

**Controlling Sputter Processes by Optimizing Magnetic
Filed Guidance and System Anode Interactions**

**D.Monaghan, V Bellido Gonzalez, Tommaso Sgrilli,
Oihane Hernandez, Genco Ltd, UK
Ambiorn Wennberg, Ivan Fernandez, Nano4Energy, Spain**

23 Years of Products and Technology from Genco



Rotatable & Planar Magnetron Sputter Cathodes • Retrofit magnetic packs • Plasma Treaters
 • Speedflo Reactive Gas Controllers • IM Ion Sources & power supplies • Arc MAX sources & power supplies • Active Anodes and Gas Delivery Bars • OPTIX Gas and Chemical Sensing • S and Se Sensor • PEC Pulsed Effusion Cell • V+DLC - Transparent DLC • IC Nano antimicrobial layer technology • Process implementation & tuning •

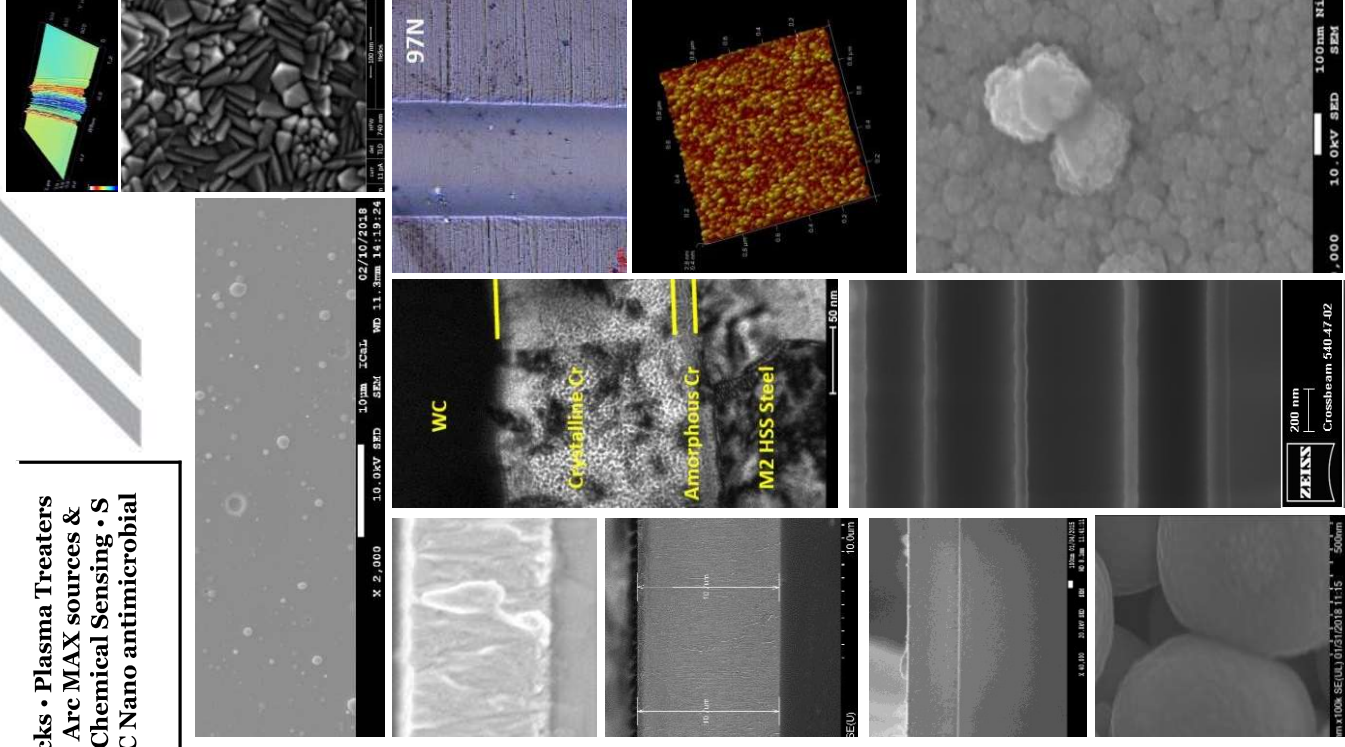

Active Anodes for magnetron plasmas

- A plasma is effectively an electric circuit with the target a negatively biased cathode and the chamber or separate mean providing the anode for the circuit return.

- Anodes are commonly earthed, although a positive charge is also possible.
- Whilst the plasma confinement in the near target area is governed by the magnetic field, the plasma spread away from the target is primarily an anode interaction effect.

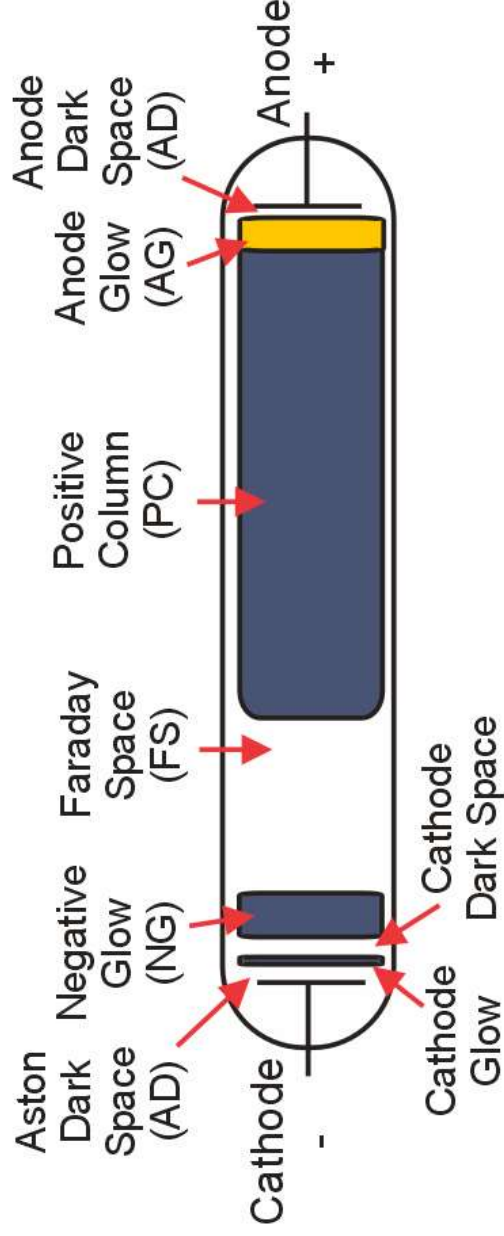
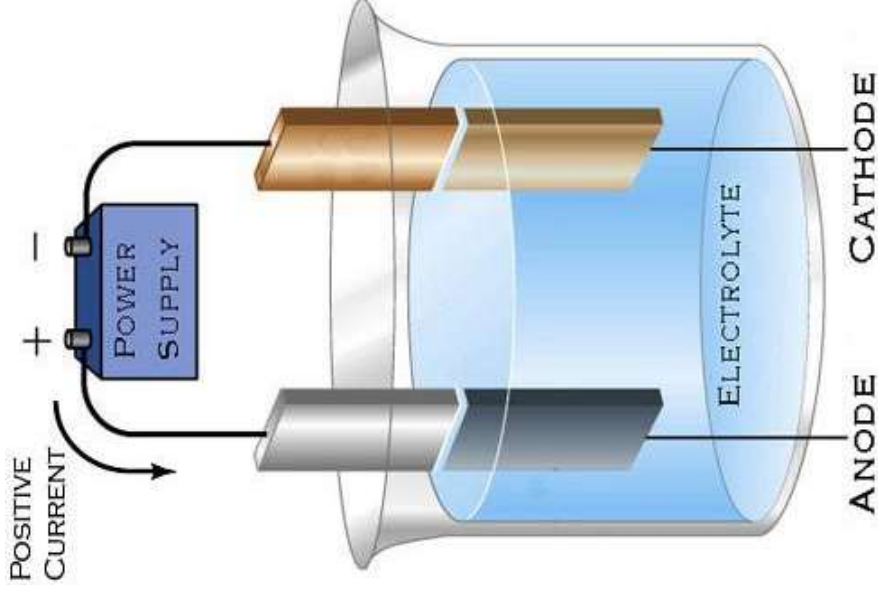

Electrons will spiral around field lines until enough energy is lost to escape the magnetic trap.

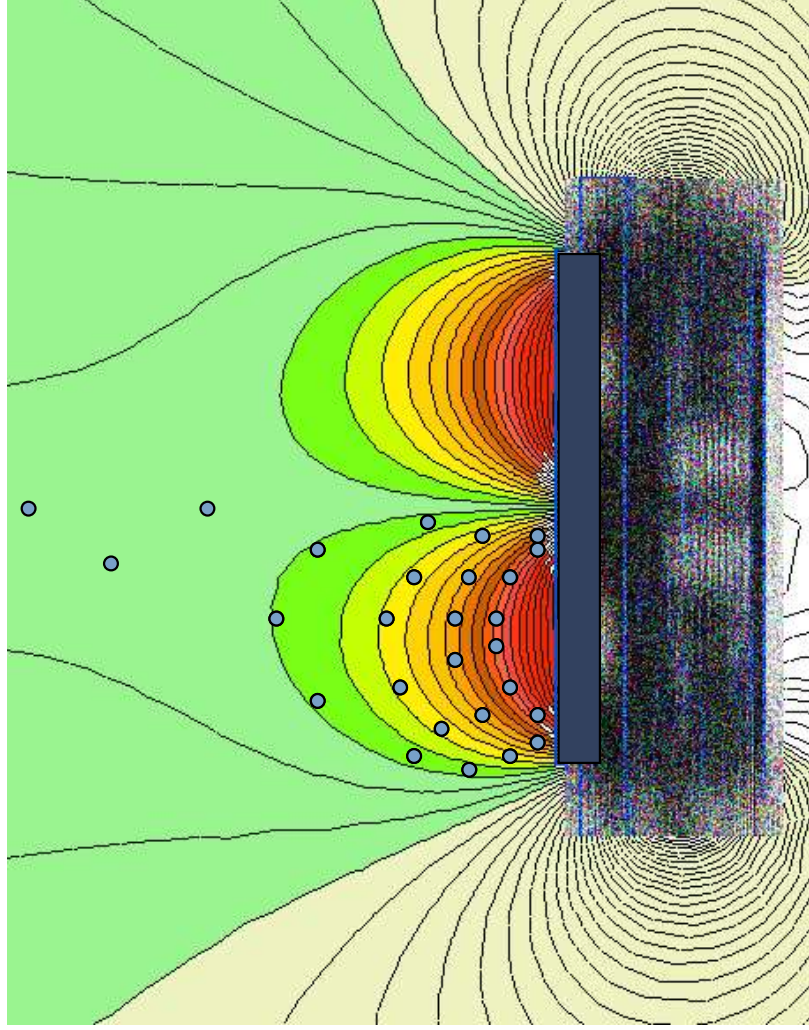

If an anode intersects a magnetic field line it will collect the electrons, so they are lost to the plasma and do not add to substrate heating

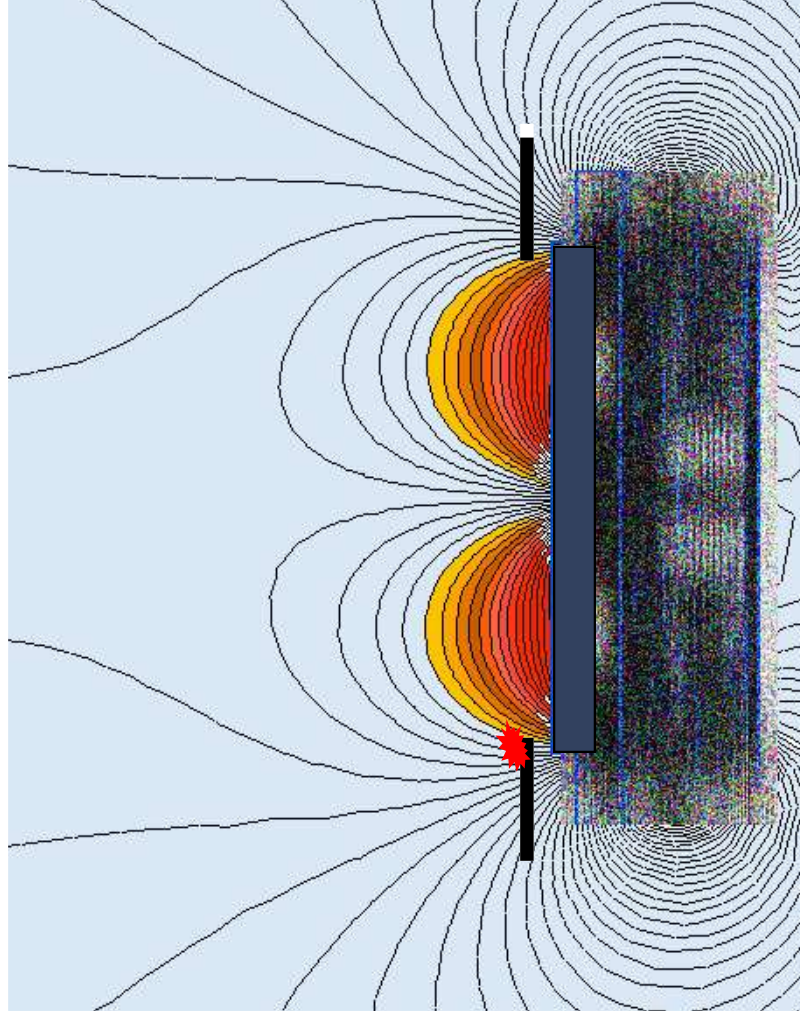

Comparison of the plasma expansion
with an anode that intersects with the
magnetic field and one moved just 1mm
to avoid a magnetic interaction

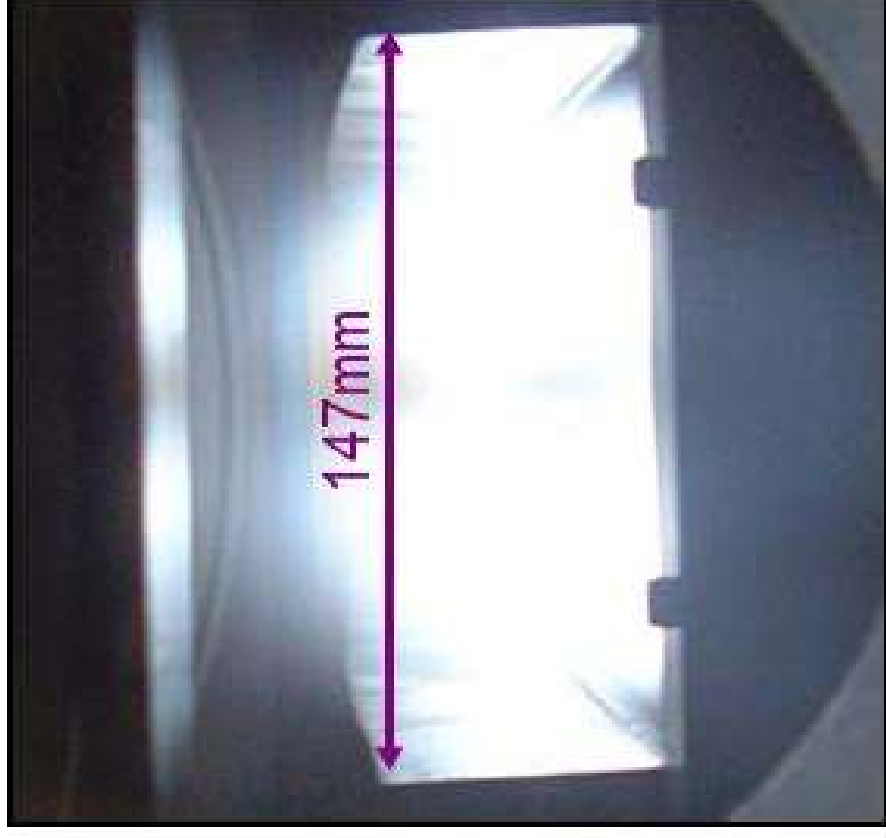
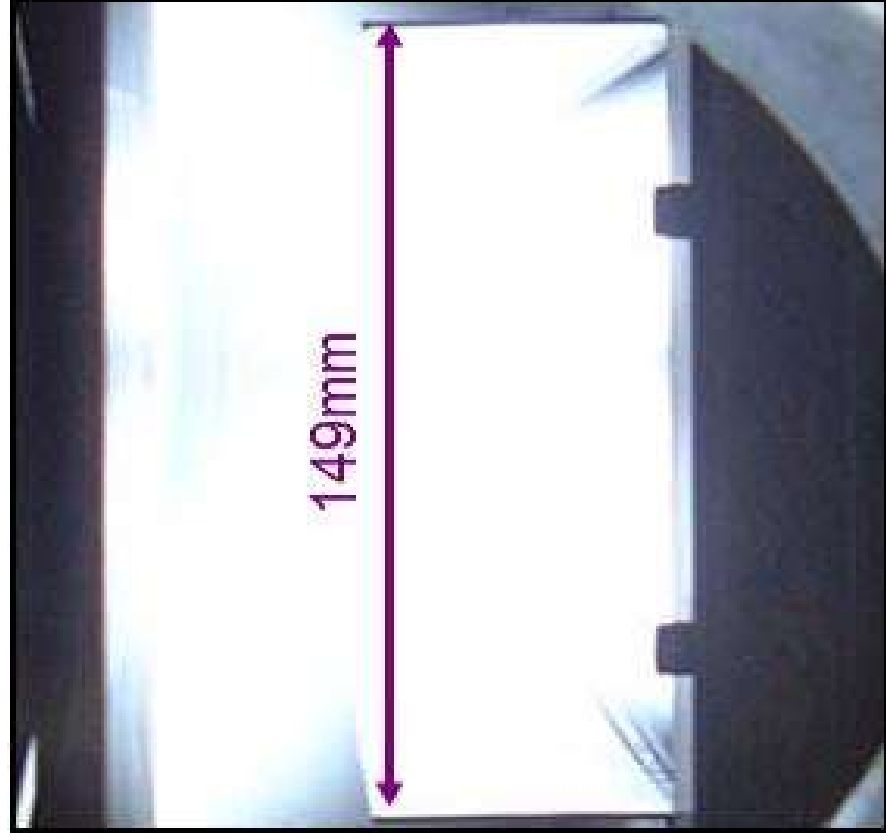

Whilst for a planar magnetron discharge
and anode can be used to confine the
plasma, typically for rotatable magnetron
no anode is close-by

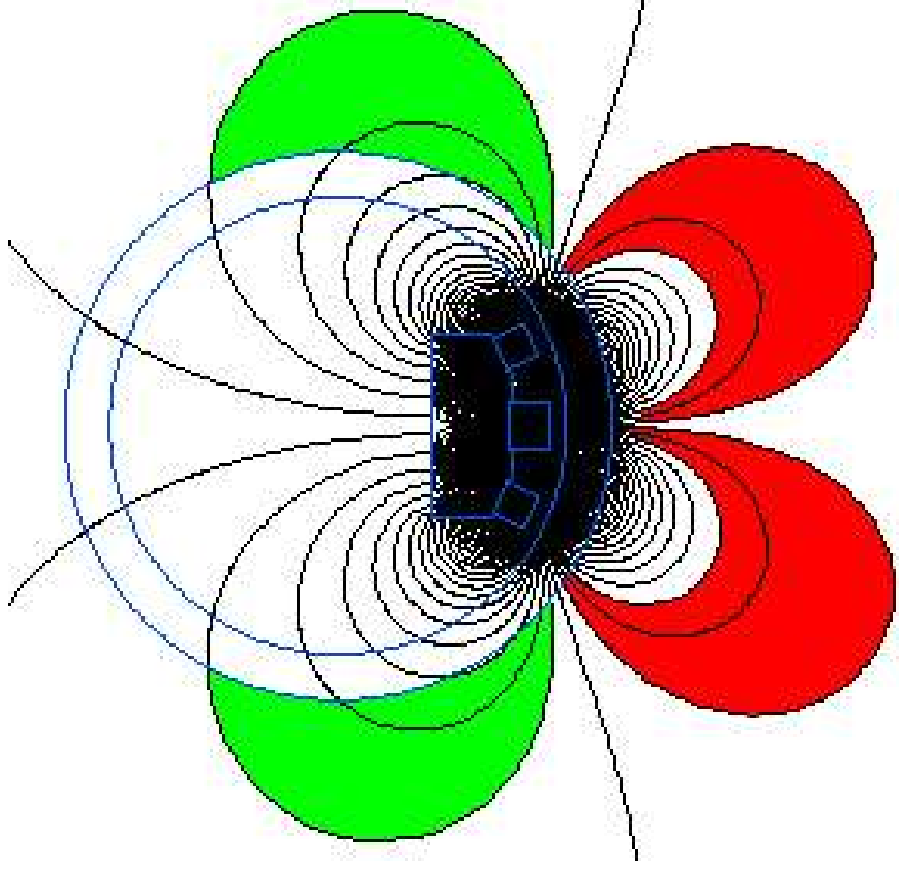
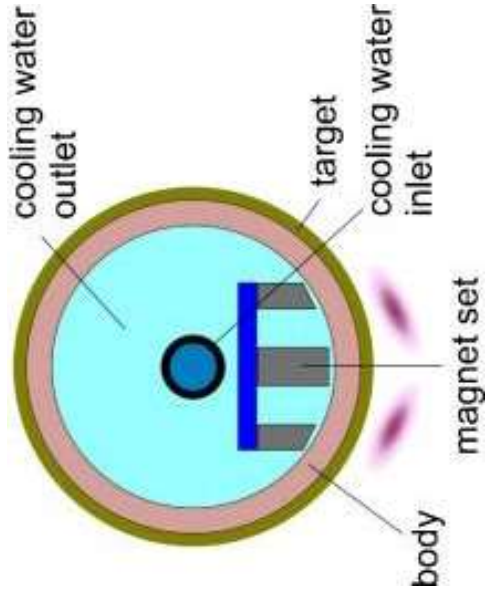

Absence of anode can be seen in a plasma spread away from the target area

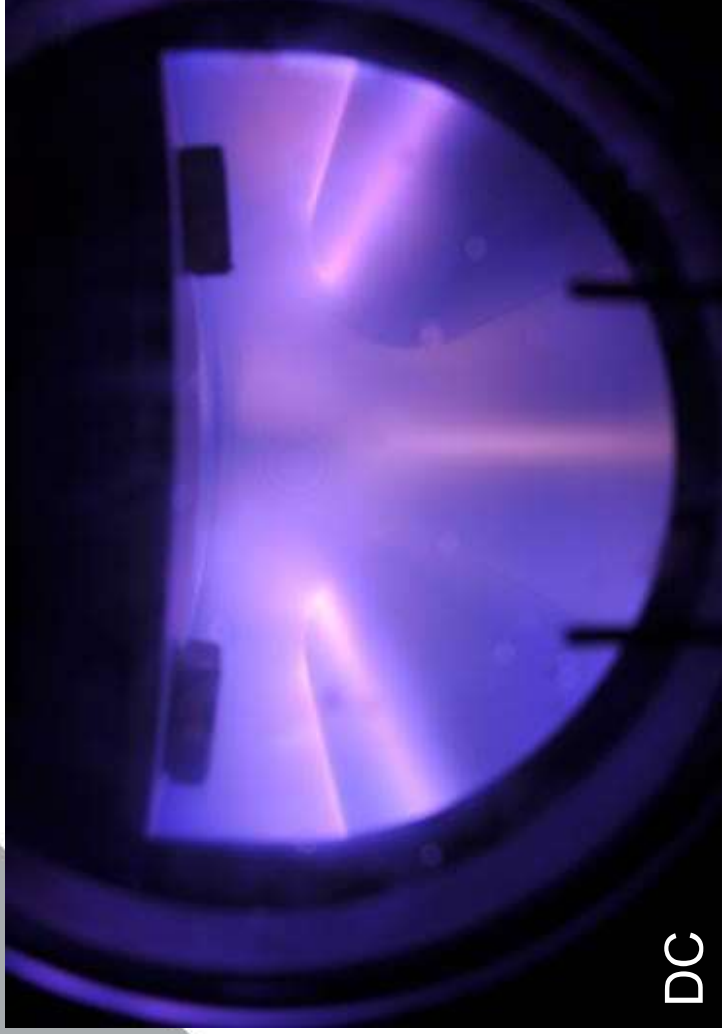

DC

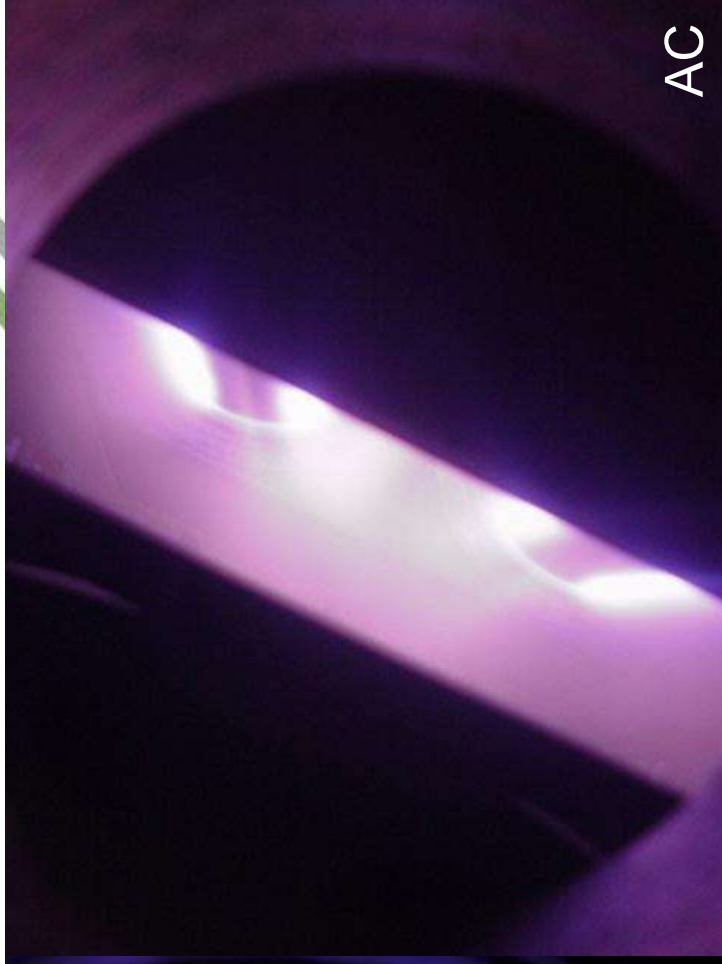

AC

- A stable anode will prevent parasitic plasma's, process drifts / fluctuations, poor uniformity and instability.
- Anodes are most effective close to the target and intersecting with the magnetic field lines of the plasma trap (like a planar magnetron).
- Rotatables work better if no extra components are close to the target as they will become coated and products flakes and defects – this present a problem of where best to locate an anode.

Gencoa Active Anodes guide electrons for process stability and activates gas passing through the anode

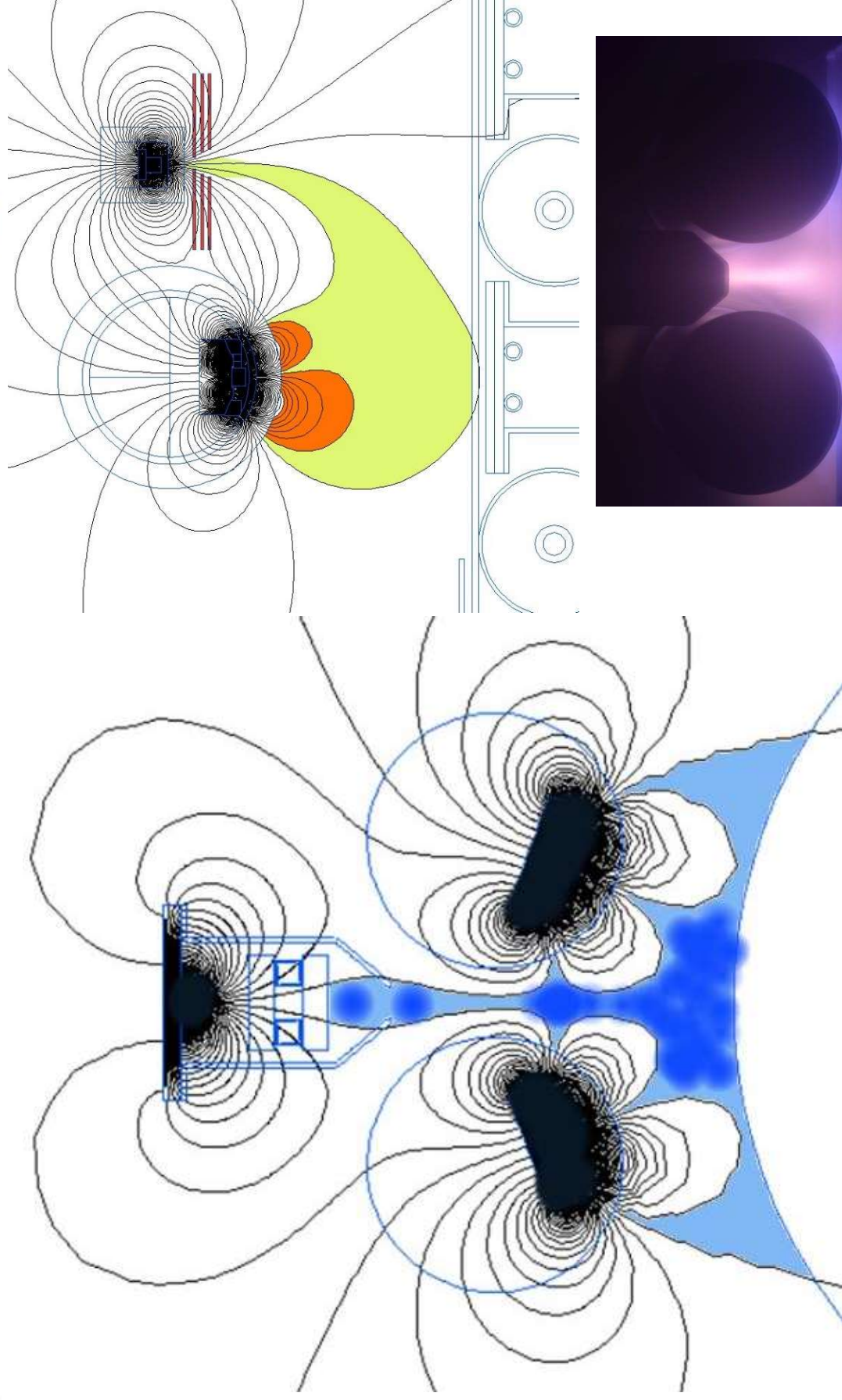

Genco have developed and patented a method to provide an effective anode away from the coating flux that can collect all electrons escaping the plasma

The method effectively combines magnetic trapping with electrostatic attraction of electrons

- The magnetic field from a single or double magnetron (shown) combined with the magnetic field of the anode to form a closed trap for the electrons to guide them to the anode – electrons do not possess sufficient energy pass the field lines and escape the trap.
- The anode can be at varying potentials but the most convenient and cost effective method is to have the anode at earth potential.
- For example, when used with AC power between two targets, the active anode improves process stability.

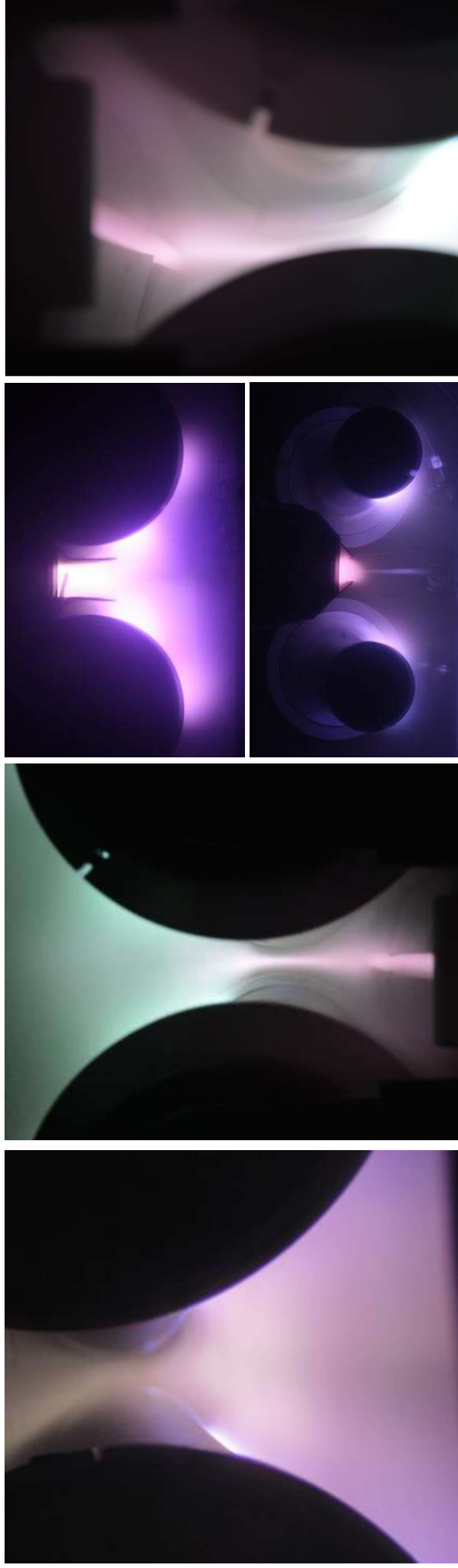

Substrate temperature reduction for DC-Pulsed configurations

Grounded anode

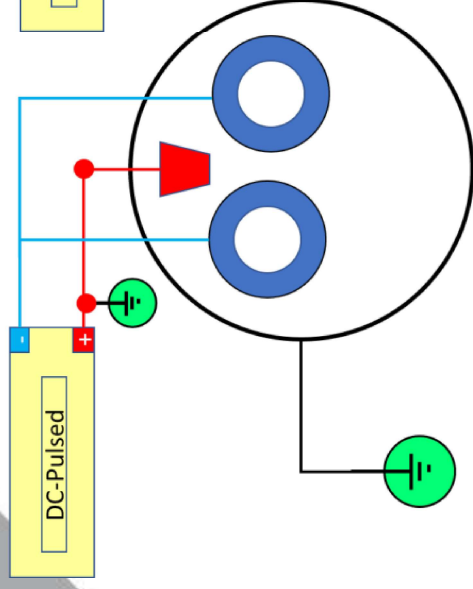

Floating anode

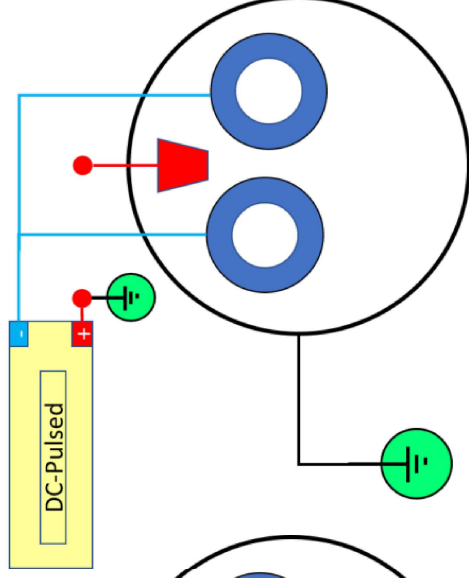

Power on (6kW)
100 kHz pulse frequency
Power split to 2 targets
Total time: 60 mins

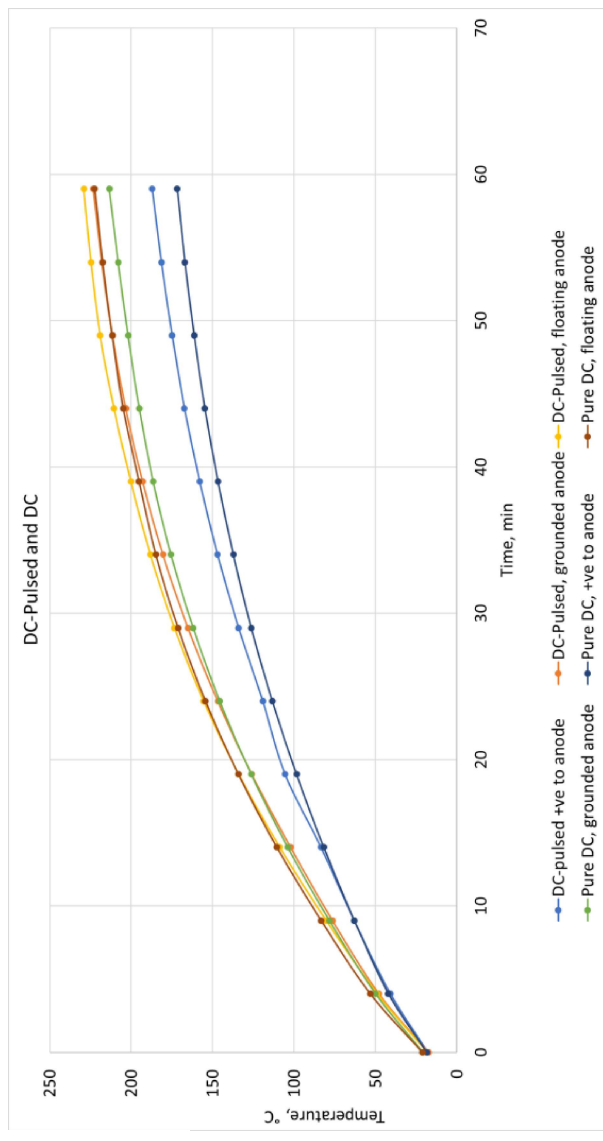
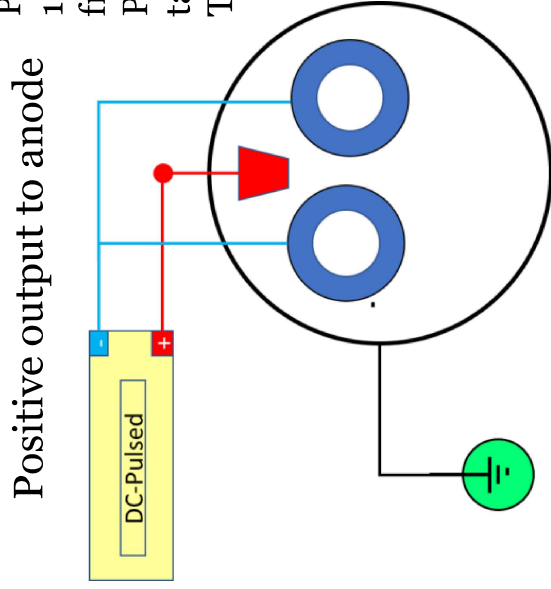

Substrate temperature reduction for DC-Pulsed configurations

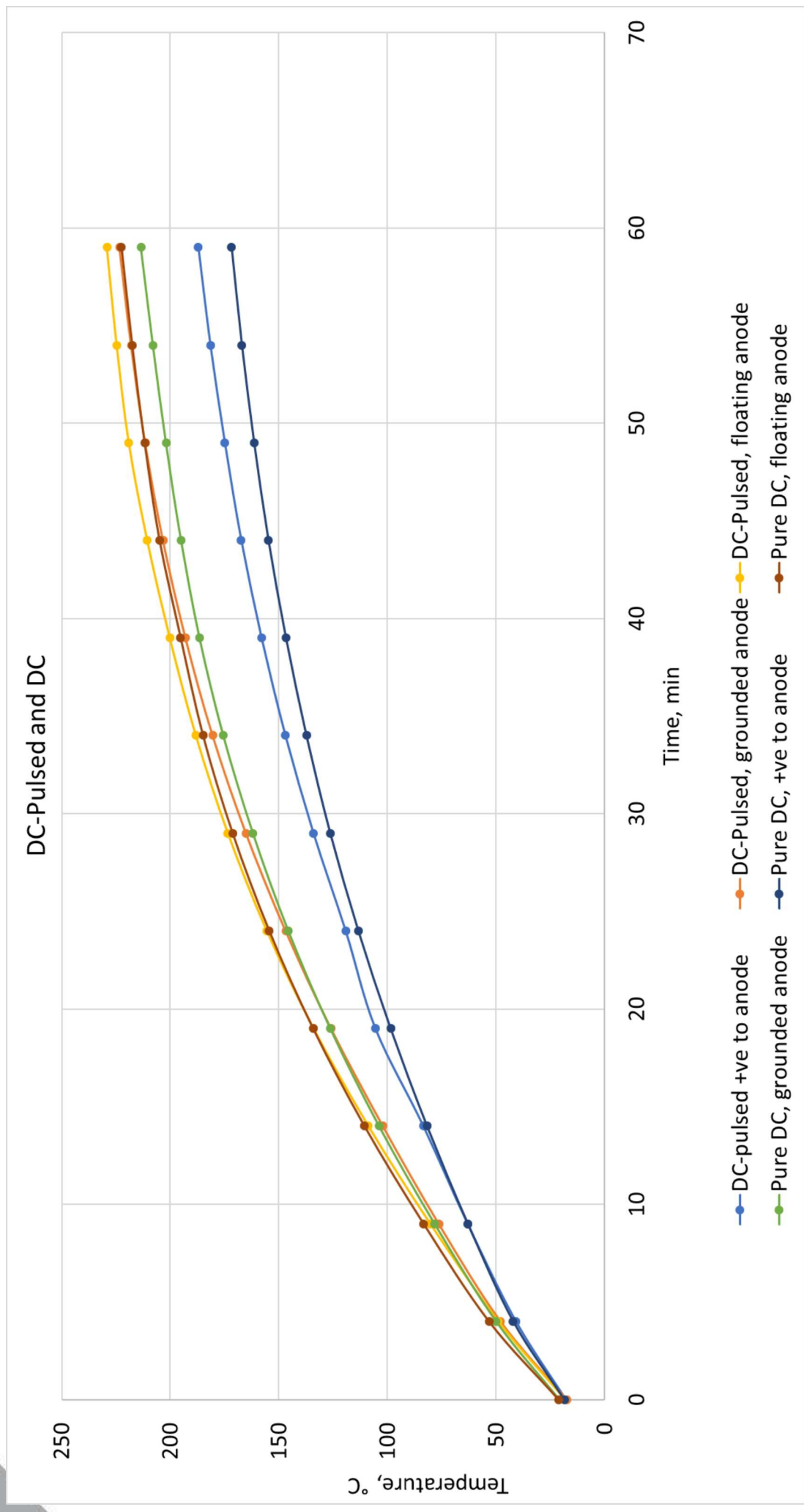

Reduced substrate temperatures with the Active Anode and DC power modes

Comparison of static substrate temperature rise from dual rotatable with 11kW DC power on each target

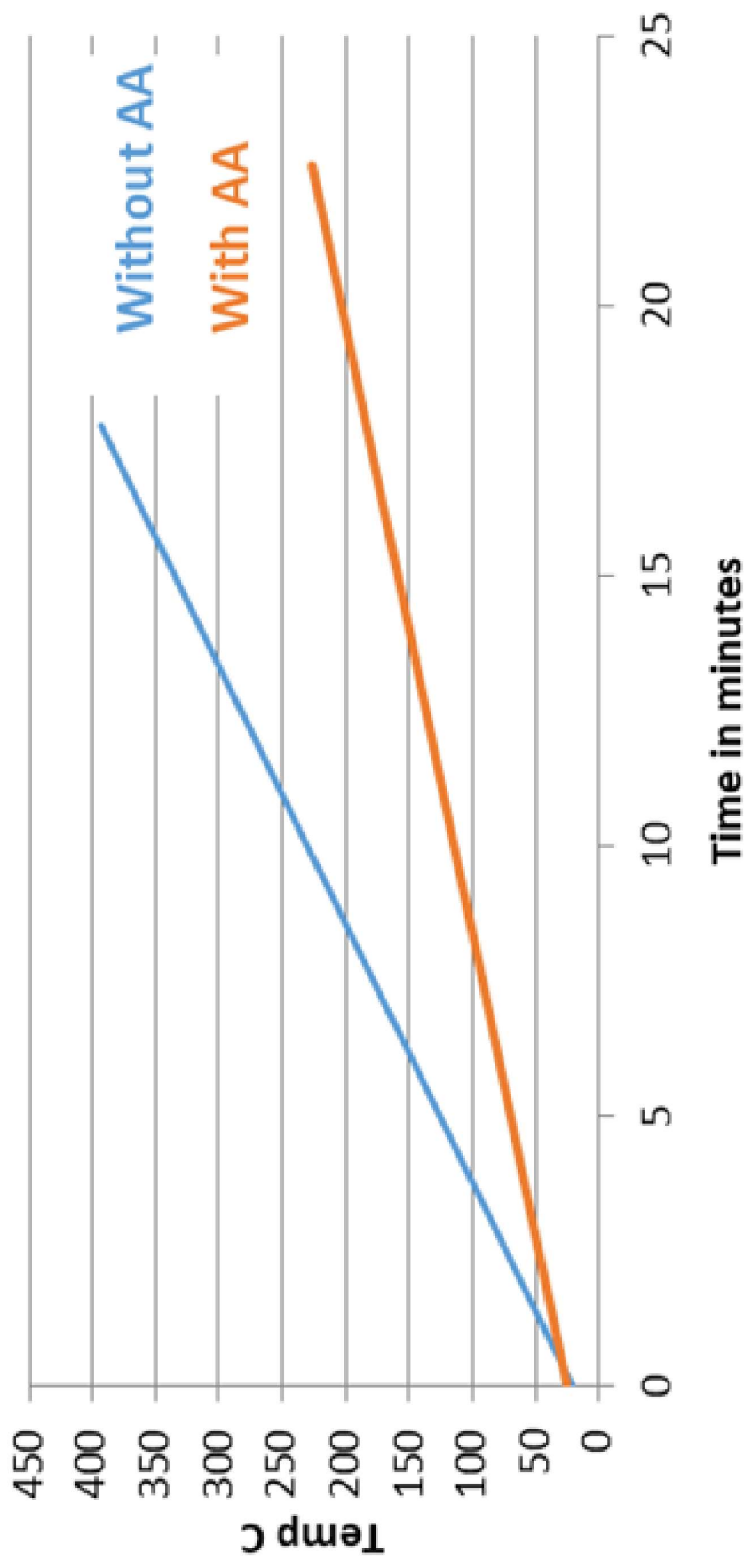

Reduced substrate temperatures with the Active Anode and DC power modes

Temperature indicator strips on the rear of substrates coated with 1 micron Aluminum with and without the active anode



Gencoac dual AC rotatable with grounded “anode”

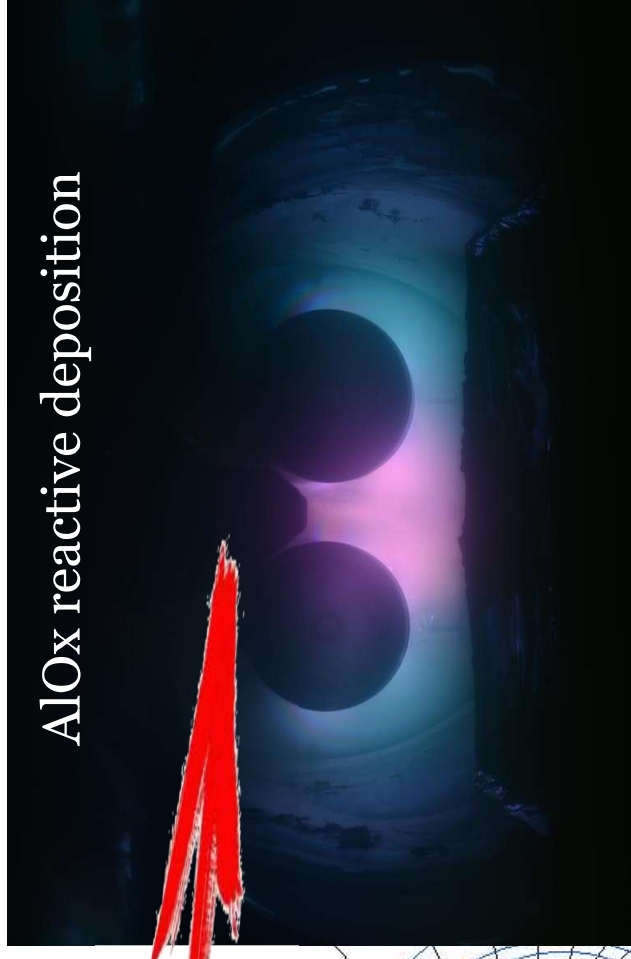
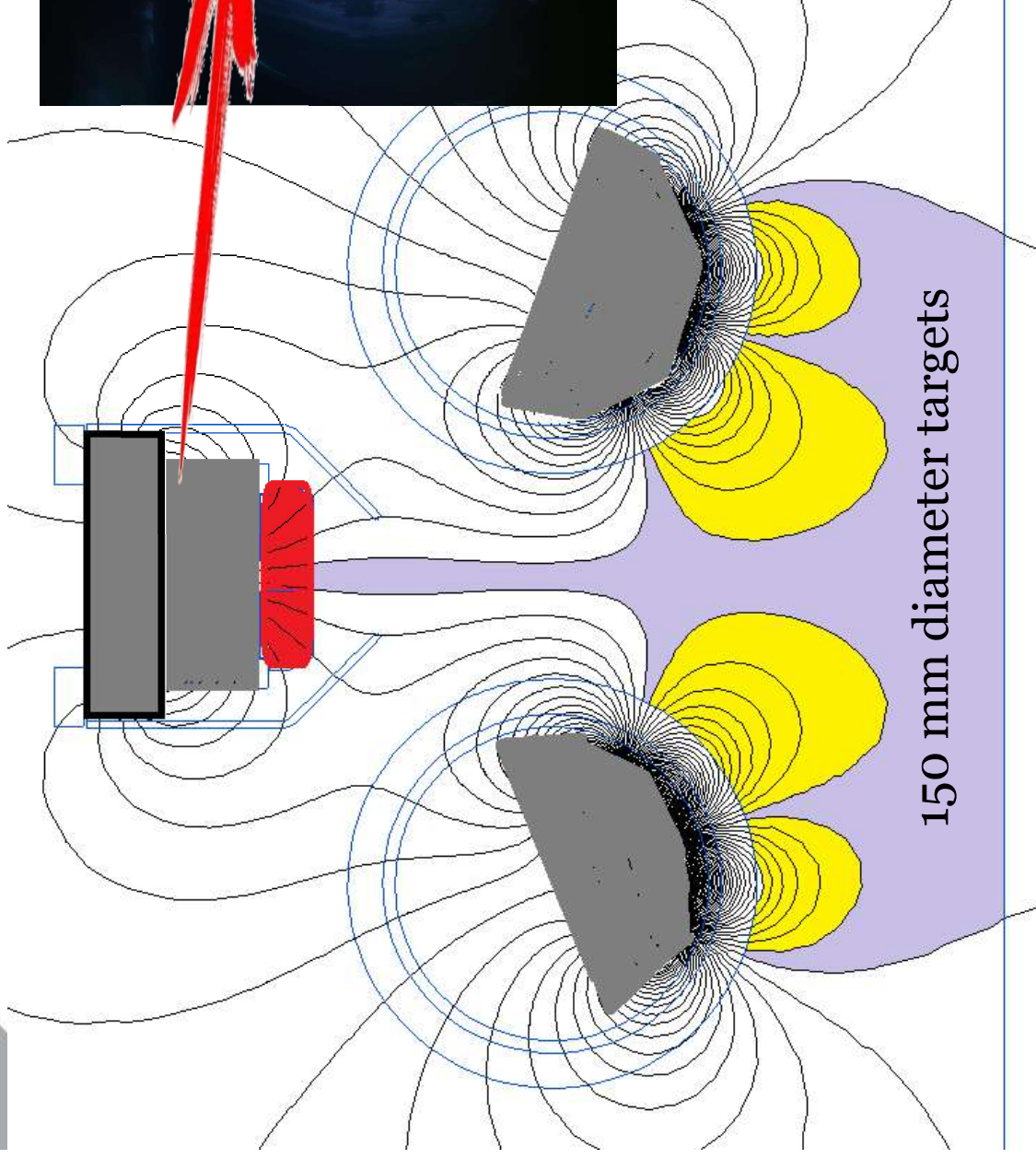

Magnetically guided “anode” assists the electron confinement in the plasma discharge

Magnetic confinement

Effect of plasma activation

Gas injection

Anode

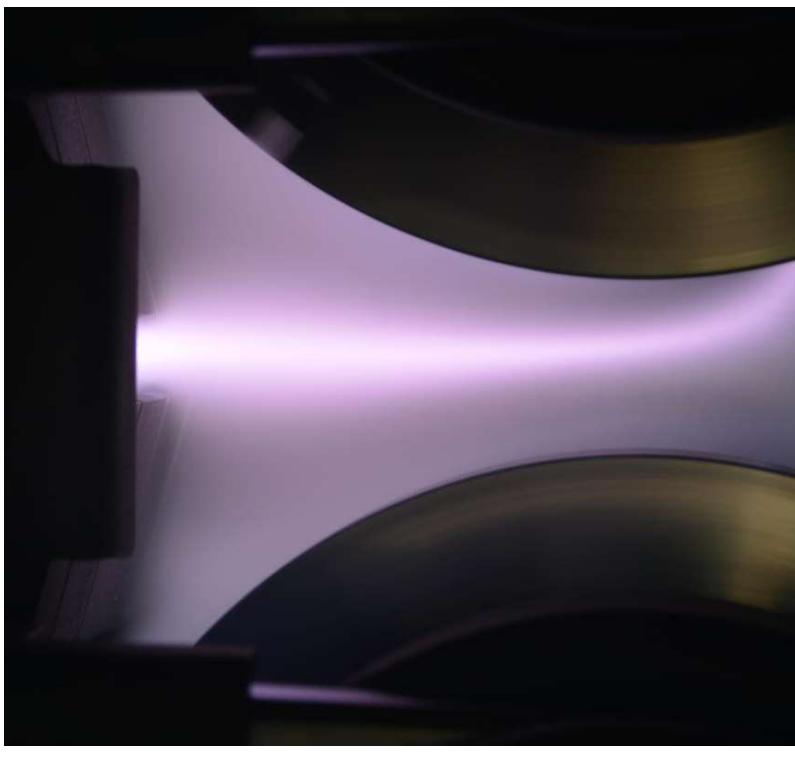
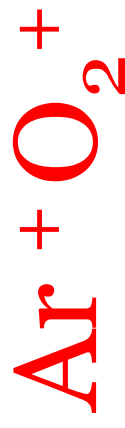
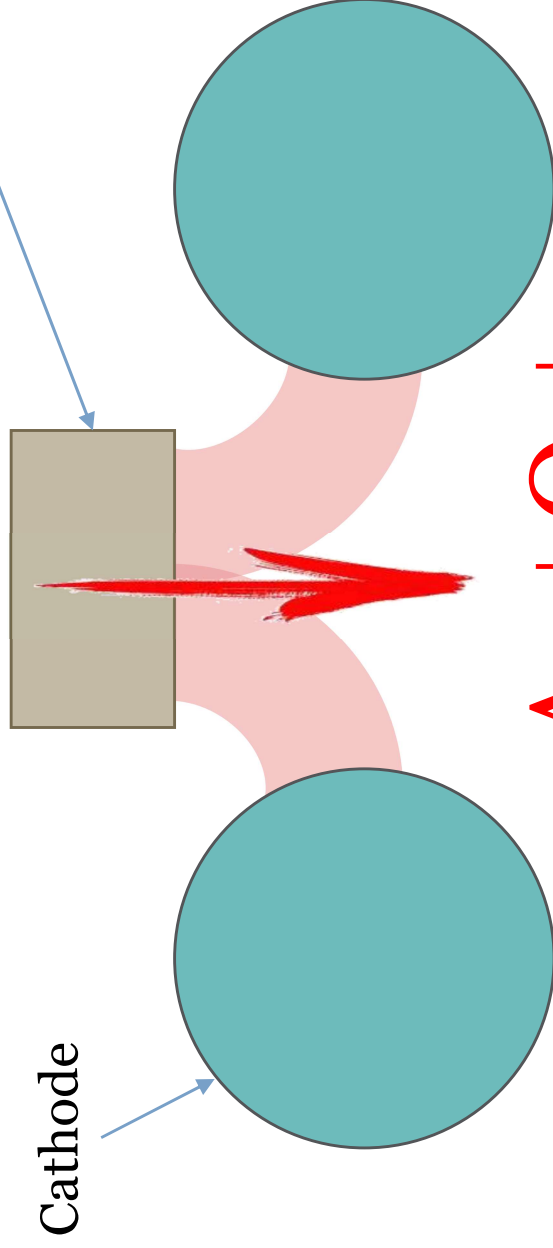

Gas injection / activation

Active anode and AC power mode produces both positive Ar and O₂ bombardment and negative

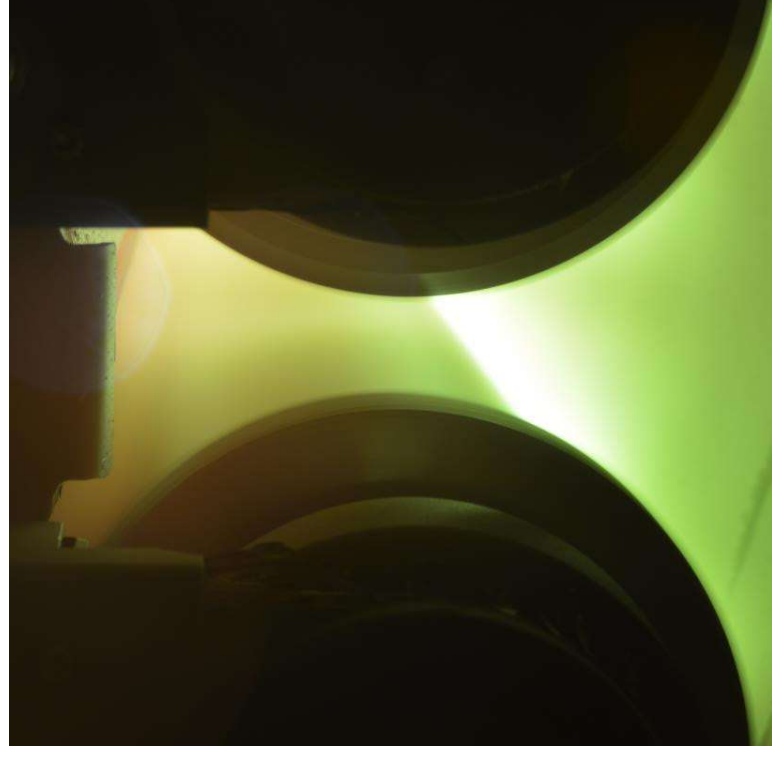
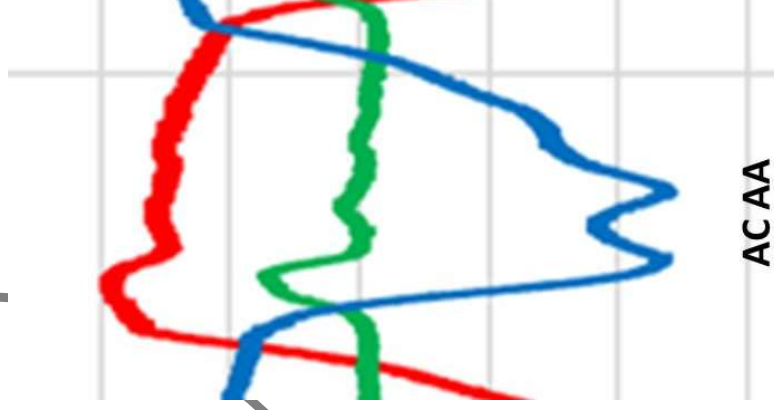
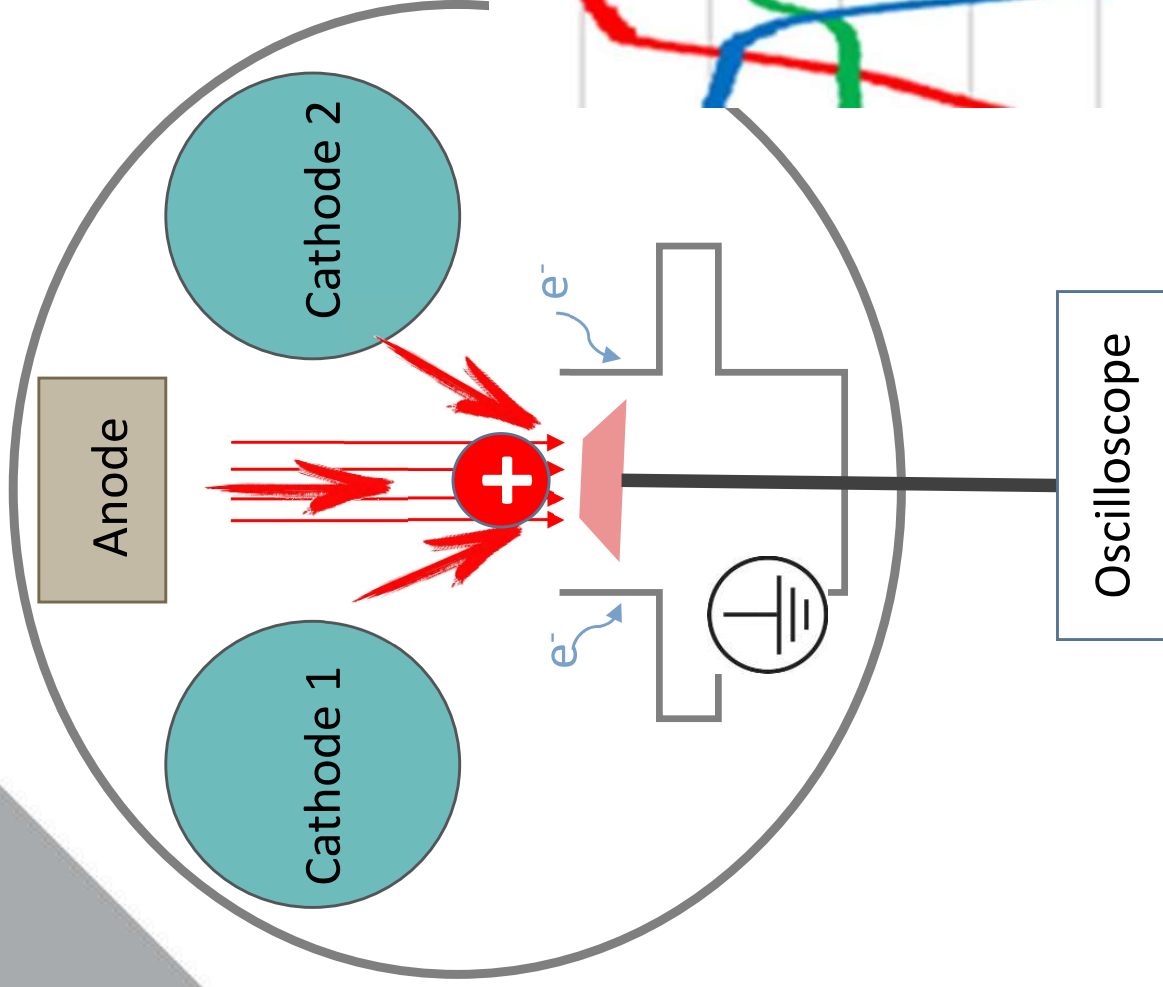

Oxygen ions positive pulse are generated in the plasma and bombard the growing film to enhance film structure and quality

Introducing O_2 through the plasma in the anode zone increases the $V(+)$ pulse intensity and produces higher O_2^+ ion bombardment

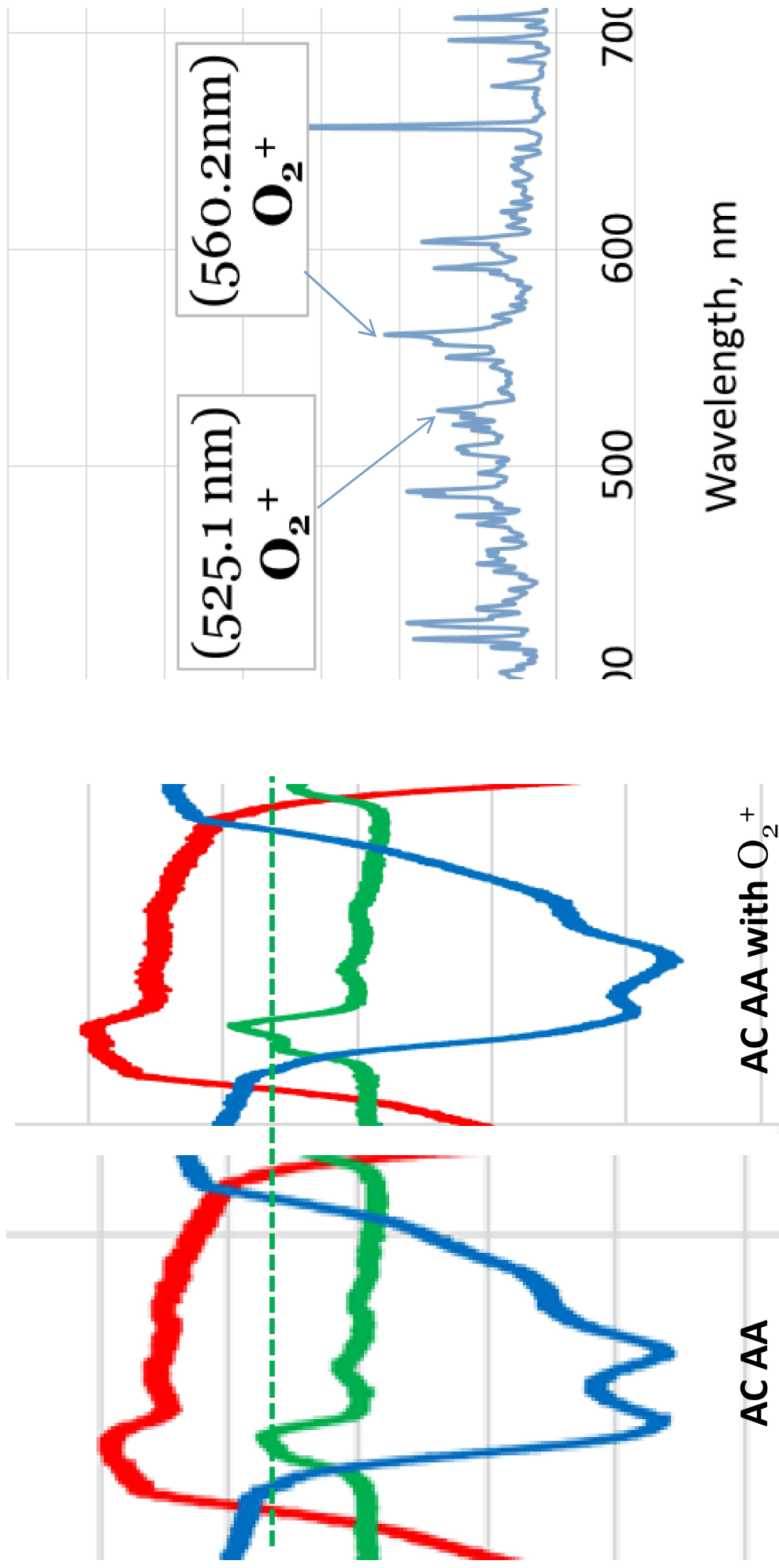

3 positive waves of bombardment followed by a negative wave produces both high density and low stress layers

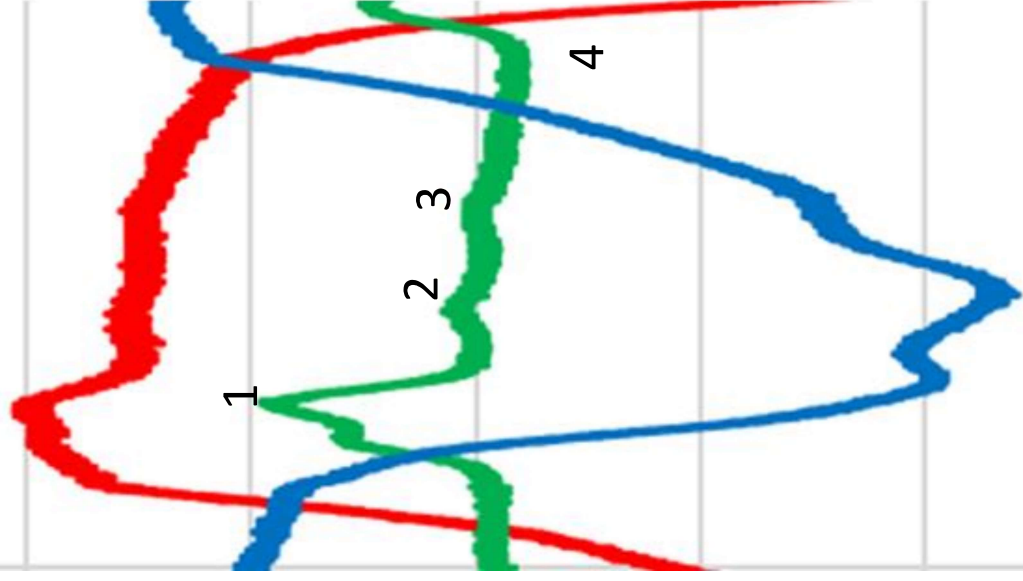

1. 10 eV positive bombardment
2. 1 eV positive
3. Neutral flux
4. Negative 2 eV bombardment (discharges the glass or plastic – avoids arcs on substrate)

The films produced by this method exhibit no stress but very dense and smooth structures.

The oxide films can be 20 microns thick and have not internal stress.

This is a result of the modulated bombardment and the combined positive and negative bombardment.

This 4 waves of energy assistance is happening at the frequency of the AC power – 20 to 100kHz.

This power and magnetic arrangement is ideal for ultra high quality optical layers at high rates.

AC-AA with O_2^+

Active anode and AC type power delivered by AE Ascent square wave type power supply with & without 'delay'

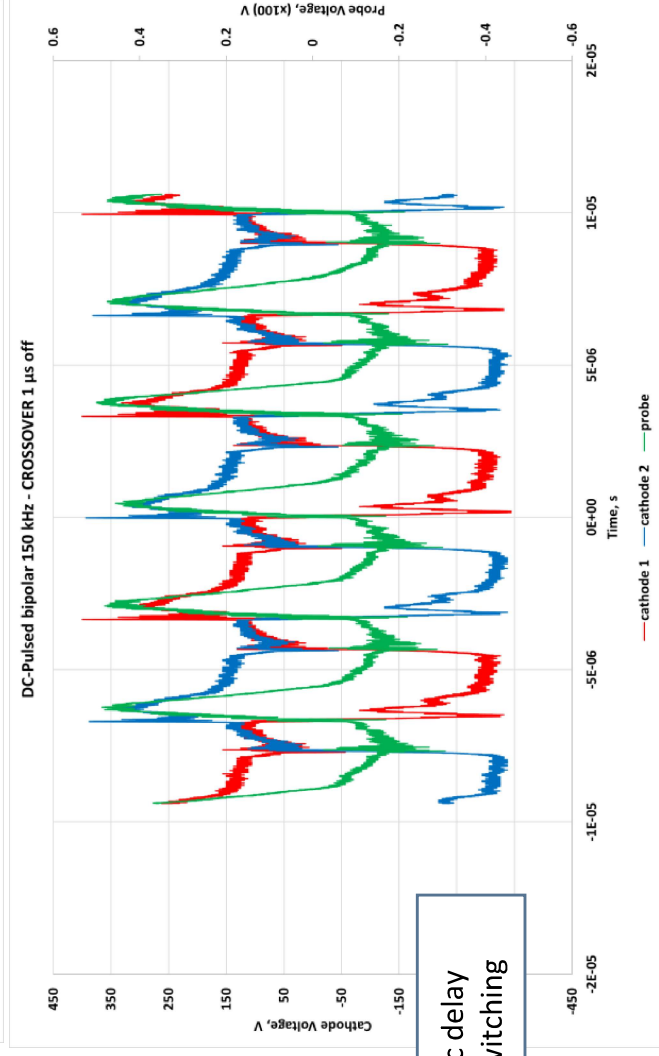
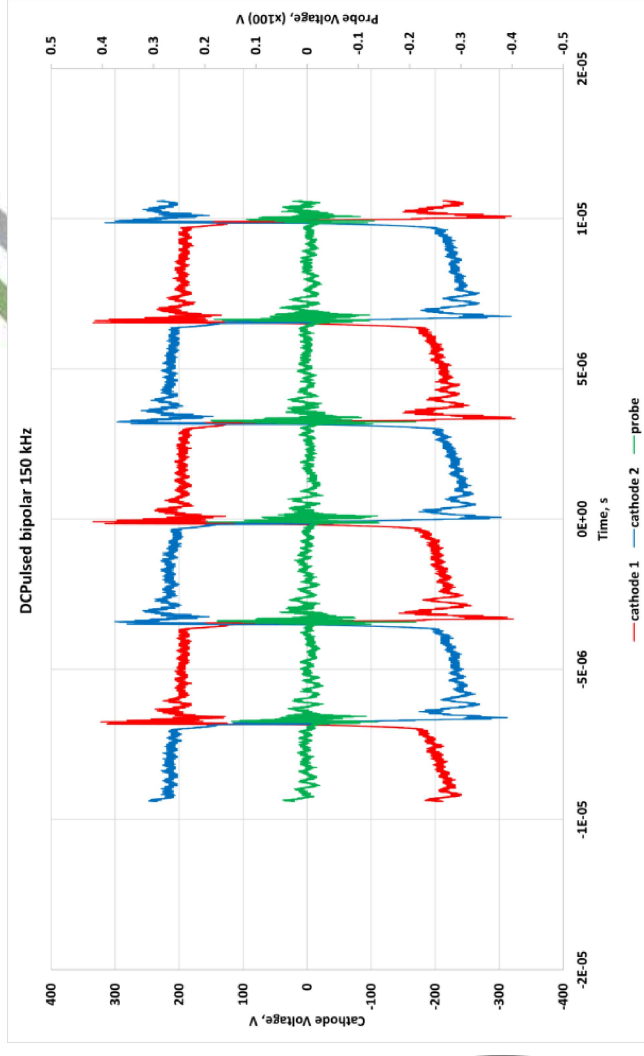
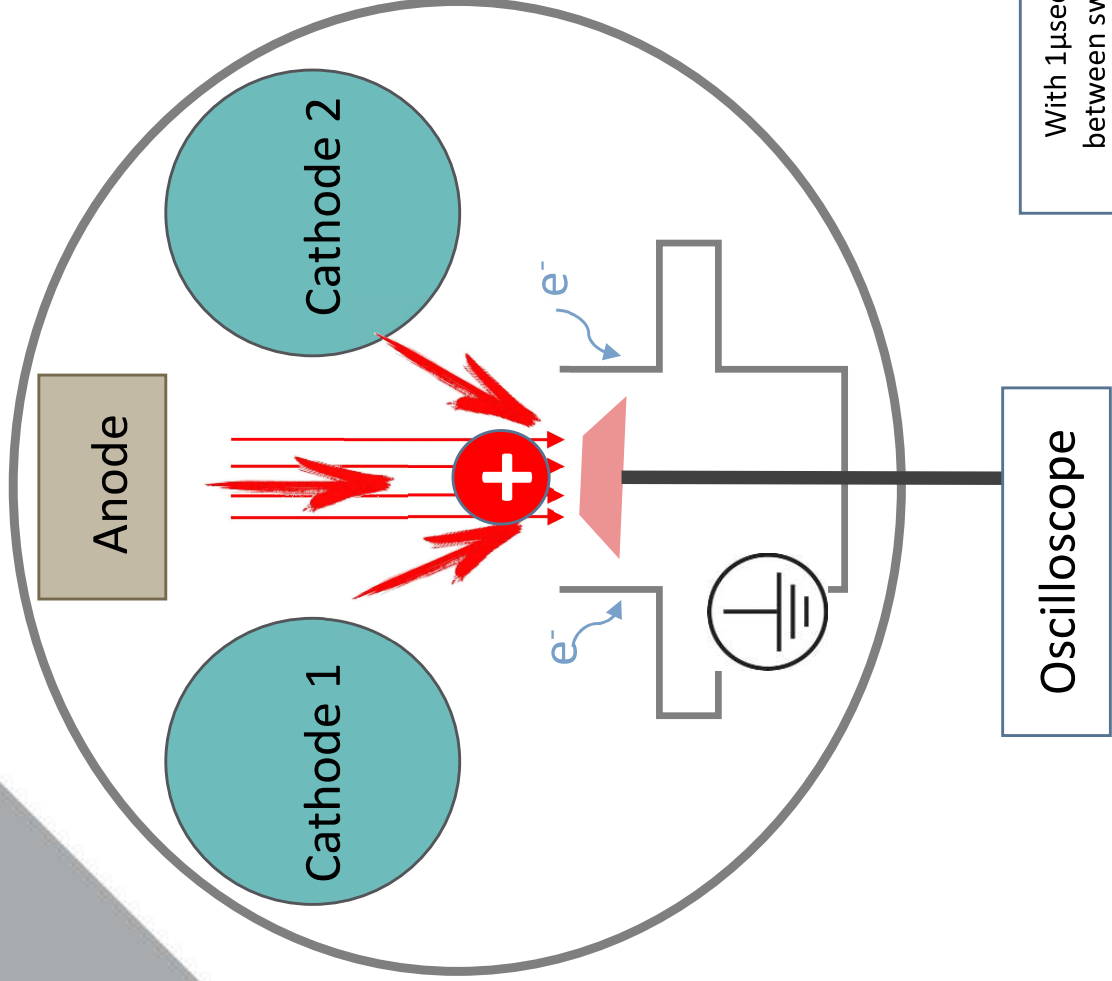

With 1μsec delay
between switching

The use of an Advanced Energy Ascent type power supply

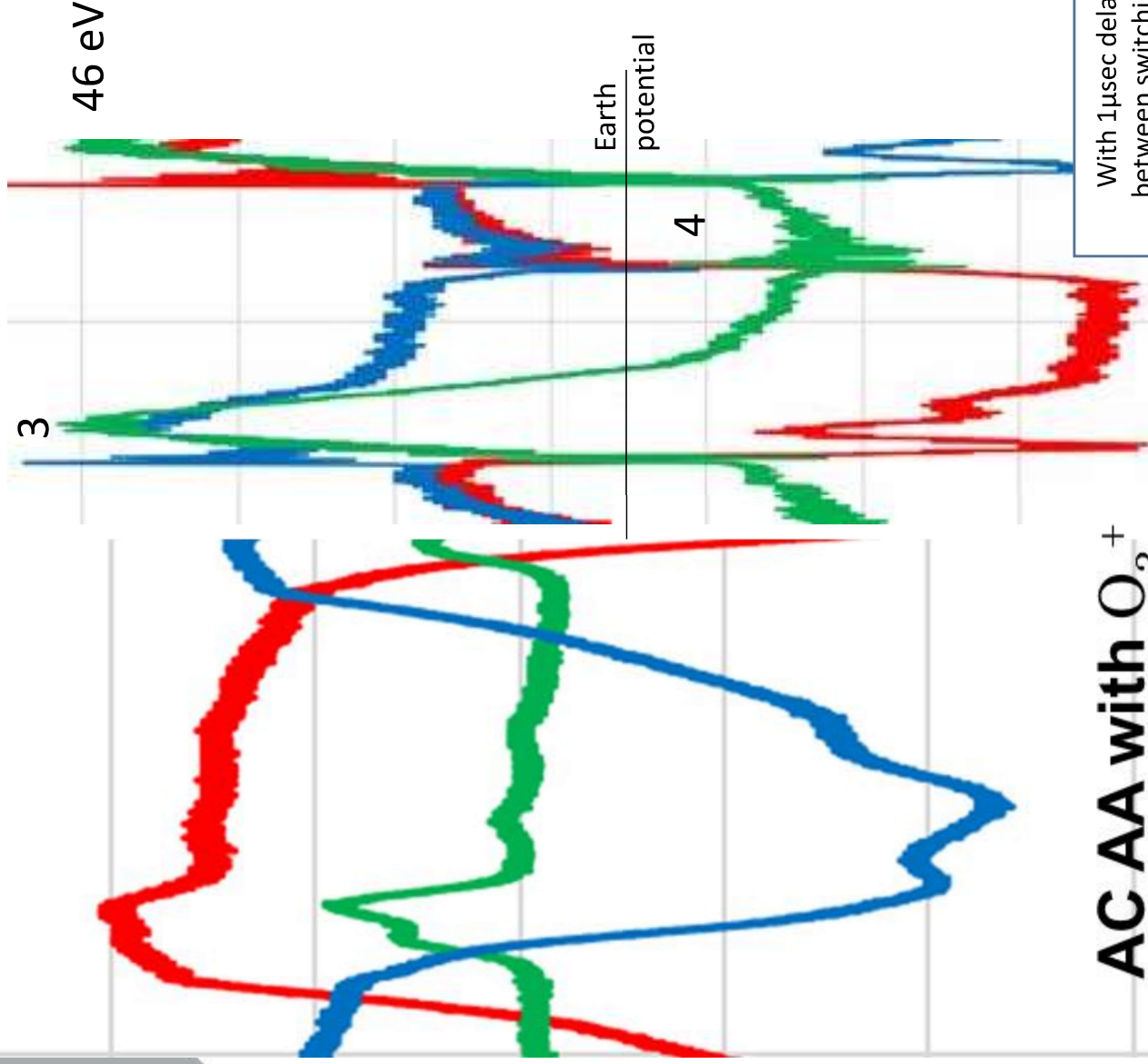

1. 10 eV positive bombardment for standard bipolar pulses like AC but more sub frequencies
2. 3 to -3 eV pulses
3. 46 eV positive bombardment when 1μsec
4. Negative 25 eV bombardment (discharges the glass or plastic – avoids arcs on substrate
4. Combining positive and negative bombardment equalizes film stress – prevents deformation.

The Ascent is more flexible than standard AC type power as the film can also be adjusted by the power supply parameters.

AC AA with O₂⁺

With 1μsec delay
between switching

AC power on the targets with a grounded magnetic anode produces superior coatings to any other arrangement

} AlOx dense coatings

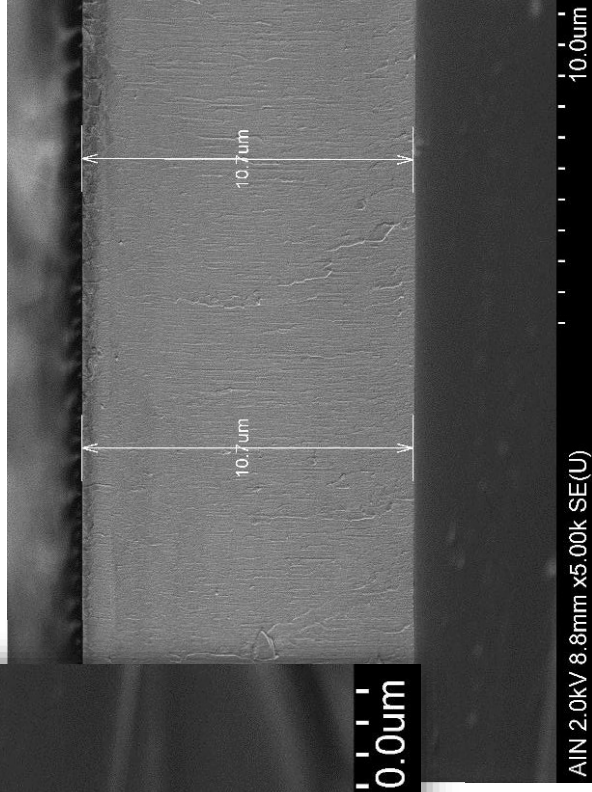
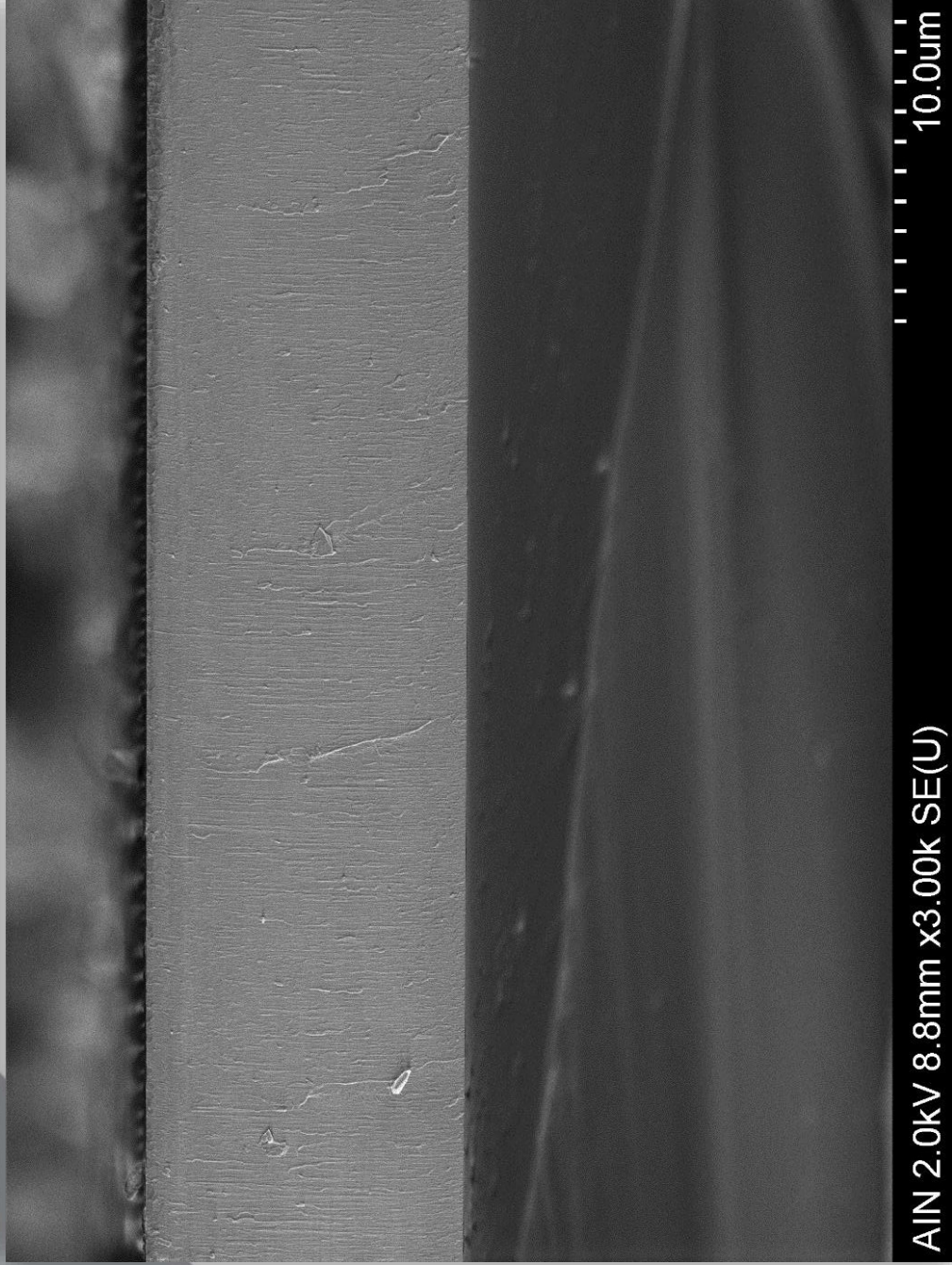

AC power on the targets without any anode does not produce as good a structure, although superior to pulsed DC

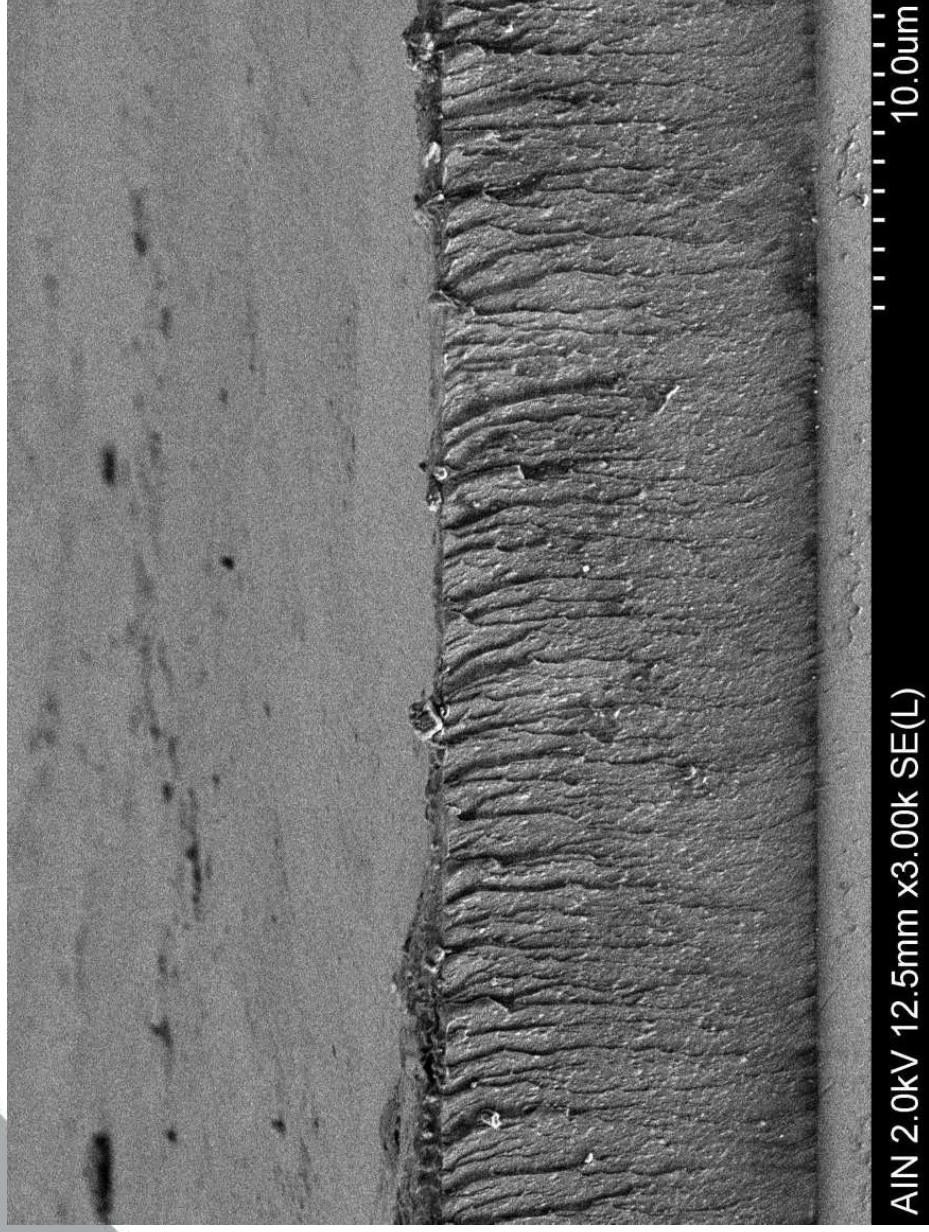

Flat top surface.
Also dense coating

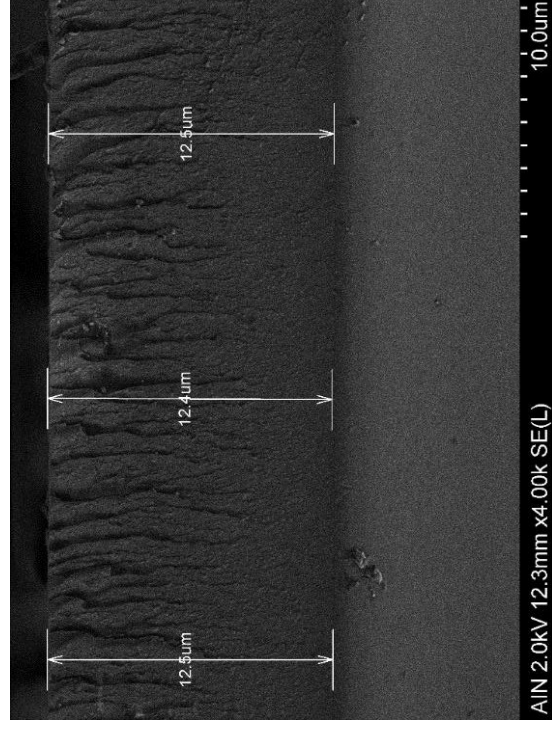

DC-Pulsed, coating structure, active anode improves the structure compared to without an anode

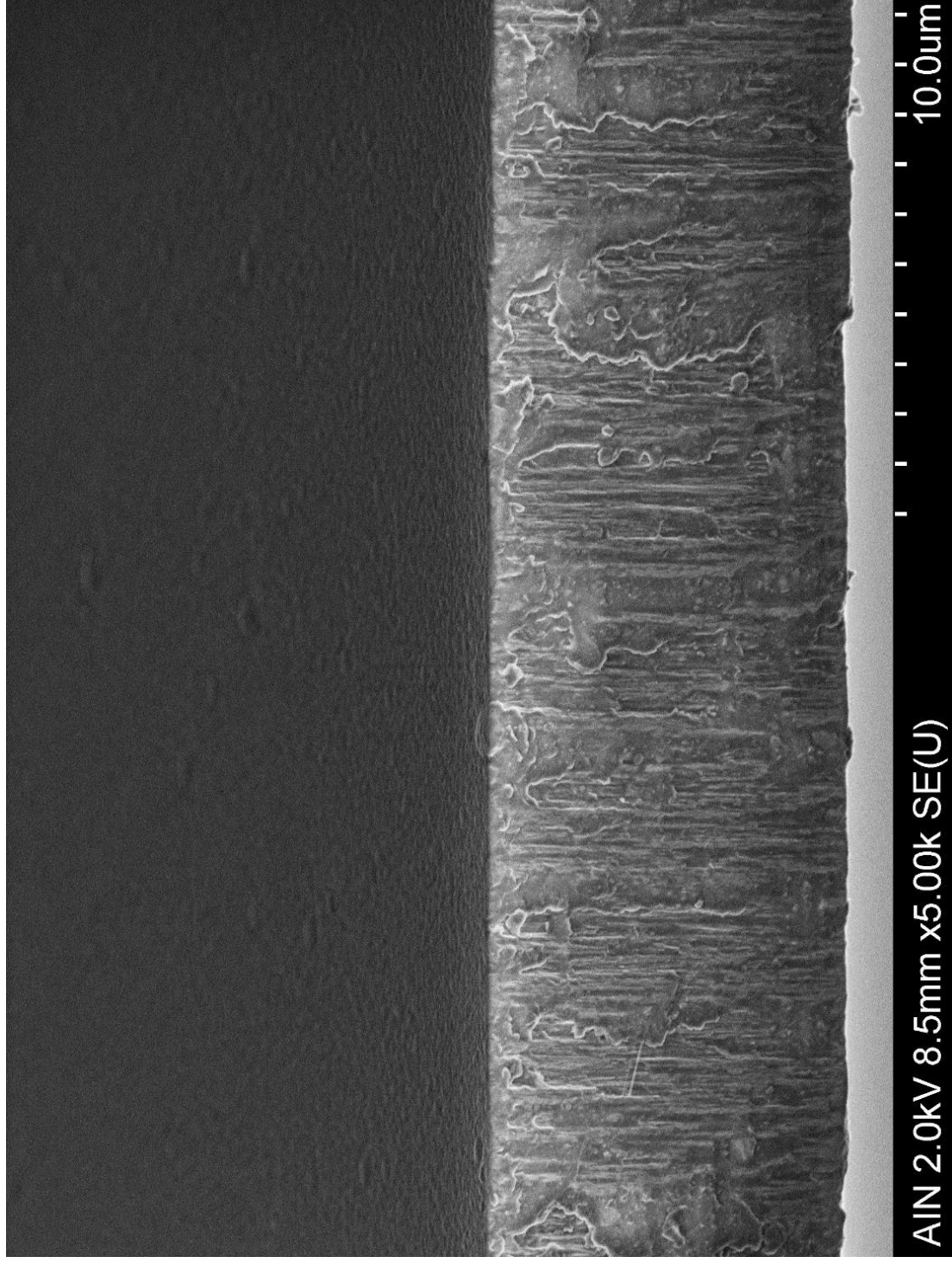

Creation of extra energy via the use of switching power modes between 2 targets and the use of a magnetically guided earthed active anode

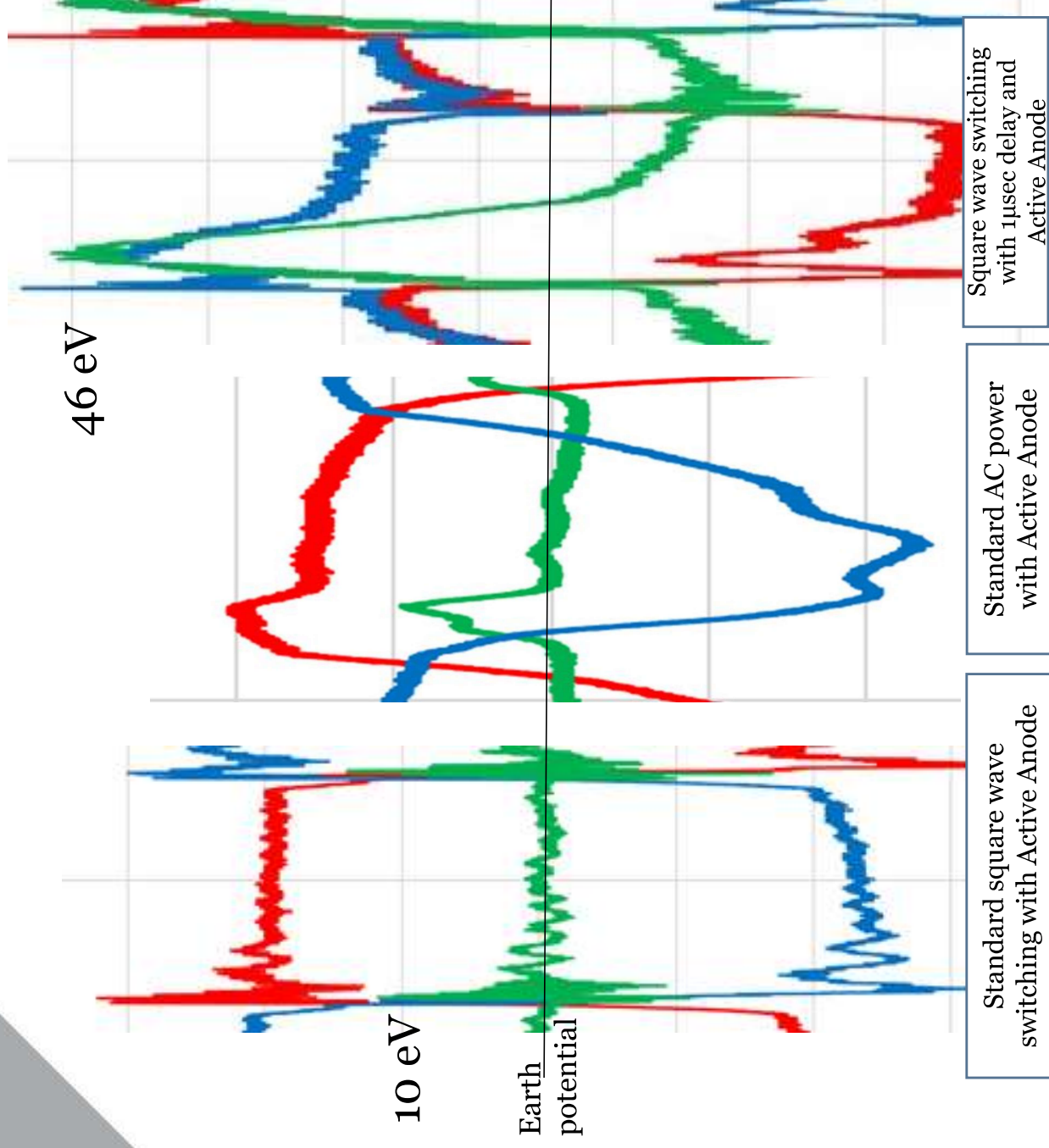

- By switching electrons between targets extra ionisation is created
- Active Anodes AA creates positive and negative energy bursts on the substrate (ideal for glass or plastic substrates without external bias)
- Introduction of a delay in the power switching

Creation of extra energy via power mode and Active Anode – comparison of coating structures

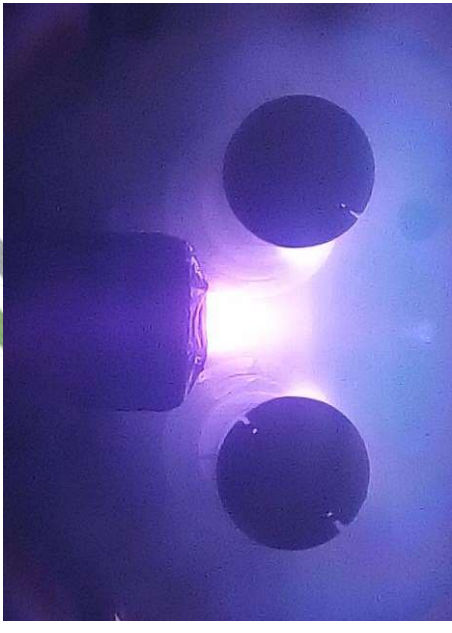

10 micron thick AlOx deposited onto glass (floating potential – no external bias) from a dual rotatable magnetron and with active anode

Increasing Energy Levels

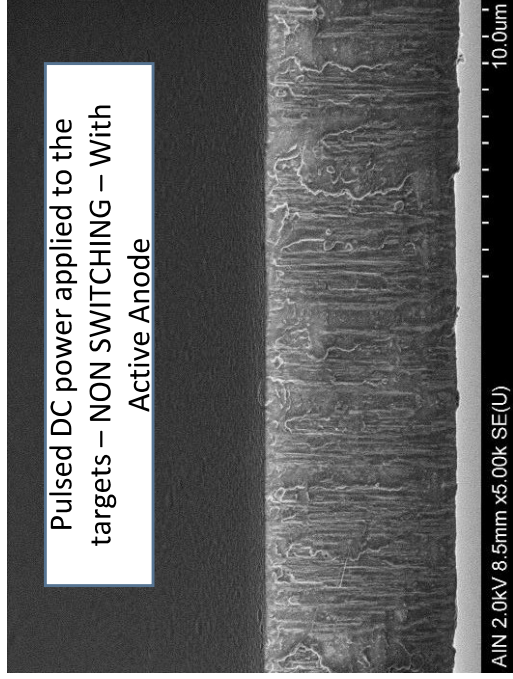

Columnar structures are recurrent when DC-Pulsed is used

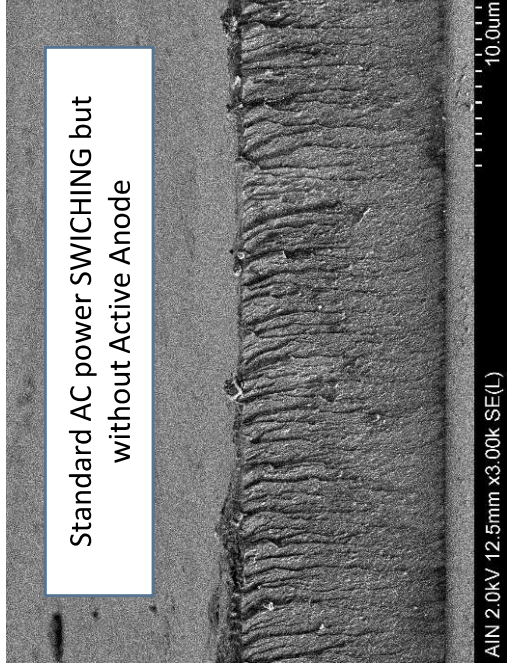

AC switching power mode has improved structure compared to pulsed DC

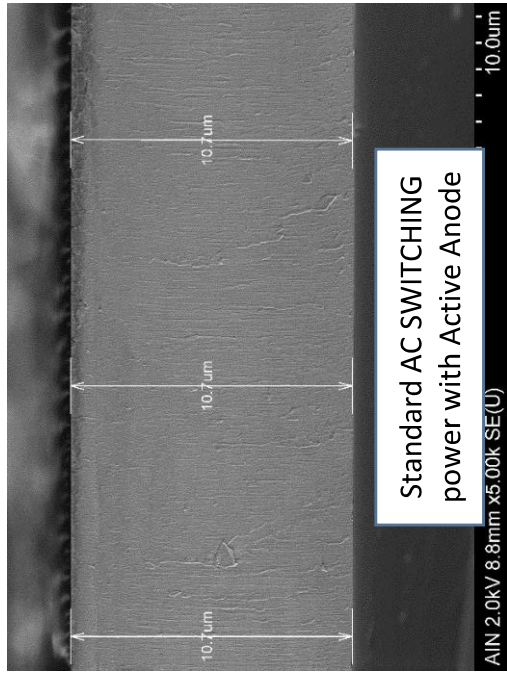

AC with active anode Produces highly dense structure

AC power with a grounded magnetic anode produces the hardest coatings compared to any other arrangement

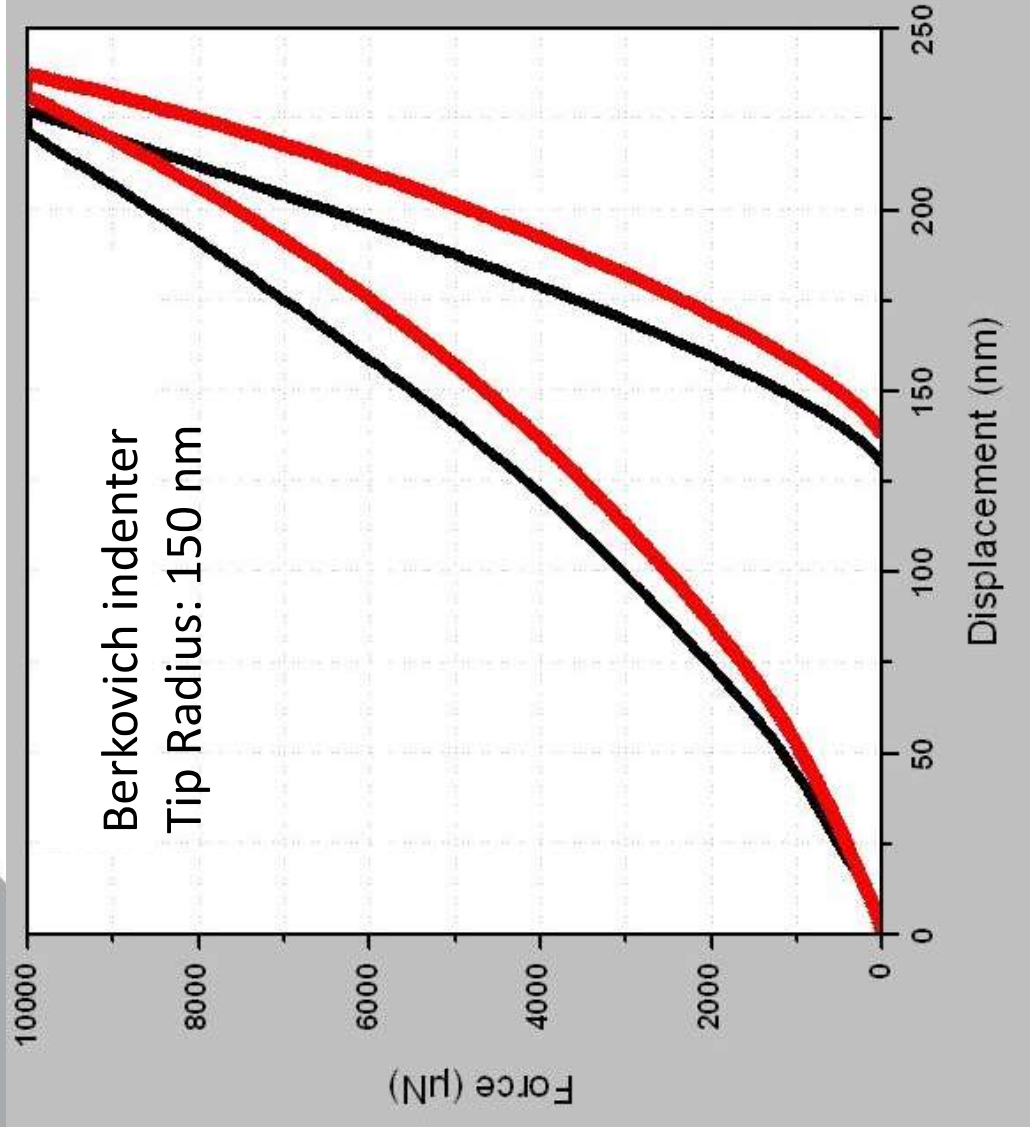

SAMPLE	HARDNESS (GPa)
DC-Pulsed no-anode	10.7
DC-Pulsed Biased anode	12.1
AC standard	11.6
AC active anode	13.1

Thanks to: Dr Adrián Miguel Lorente*, Dr José Fernández Palacio, Dr Gonzalo García Fuentes, AIN, Cordovilla, Spain
*AMiguel@ain.es

Effect of positive pulse reversal and active anode on the hardness of sputtered carbon

The hard carbon deposition method uses a positive pulse reversal via the power supply combined with electron guiding into an active anode - patent pending

The higher the positive pulse, the more the bombardment and the harder the carbon layer

This 'smart' ion assistance does not require additional sources

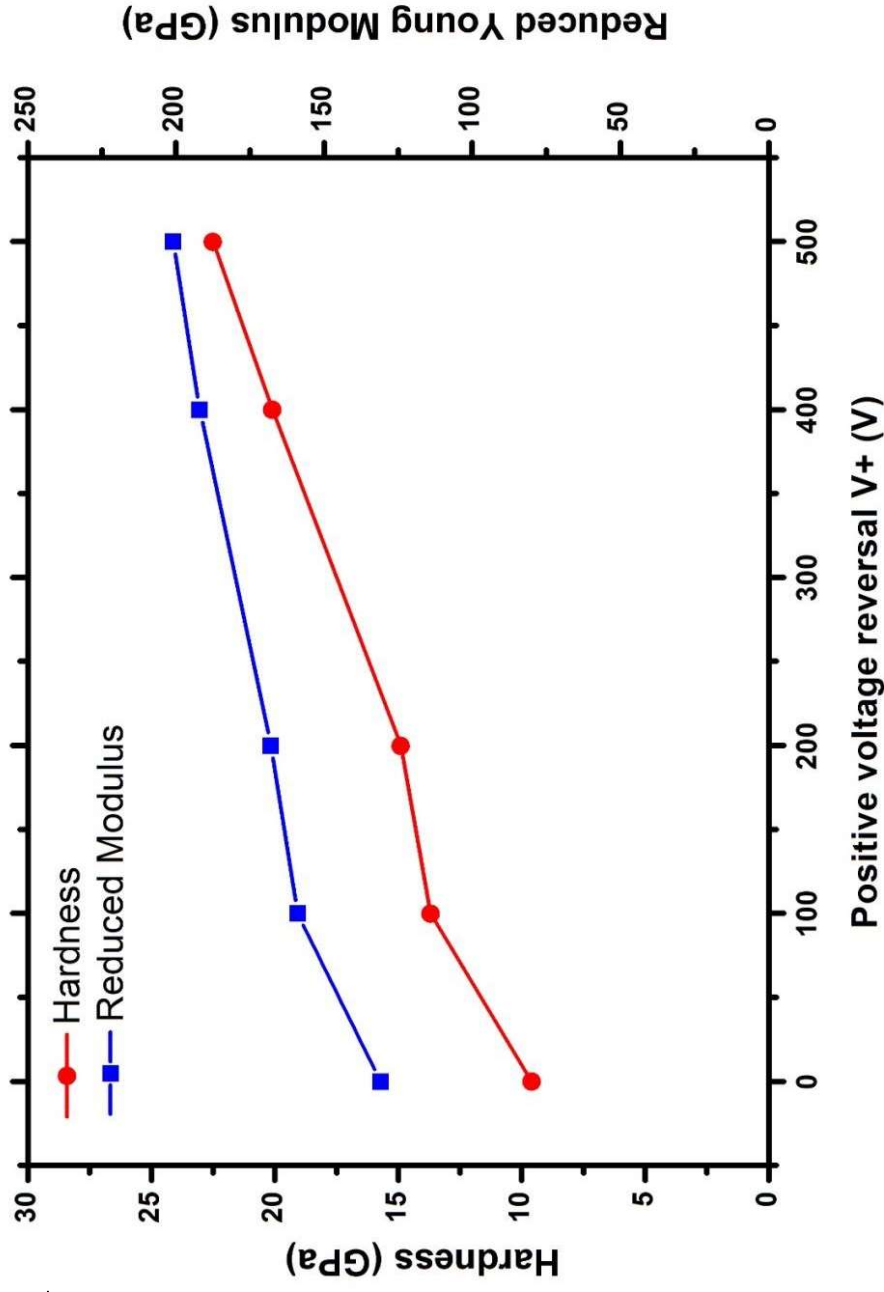



Gencoa Active Anodes available in two forms for switching AC type power or DC type power modes

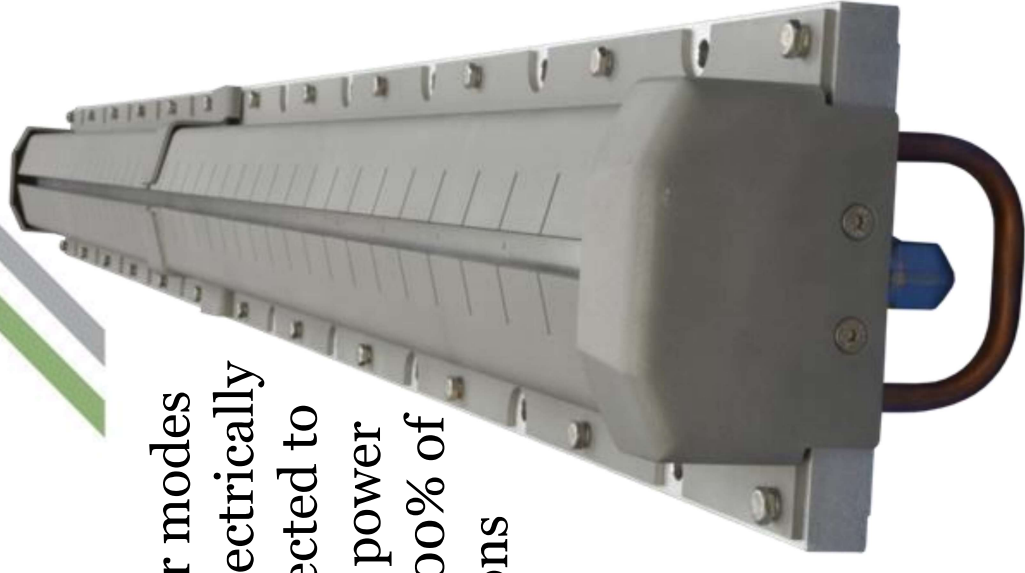

For DC type power modes the the anode is electrically floating and connected to the positive of the power supply to collect 100% of the plasma electrons

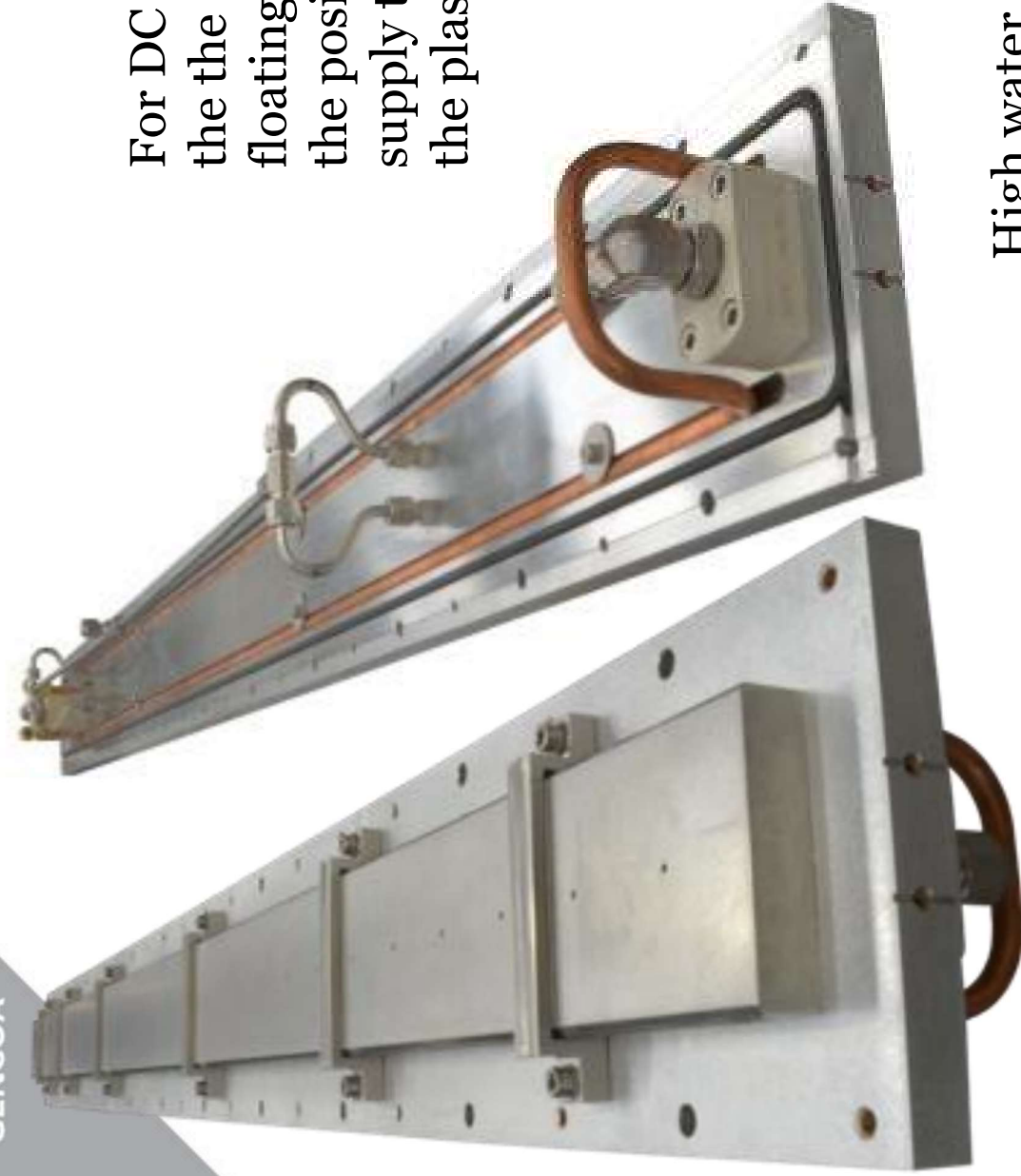

For switching double cathode AC power the anode is electrically earthed

High water flow to the anode structure ensures efficient heat removal and high power capability

Genco Active Anodes can be mounted internally or on the chamber wall

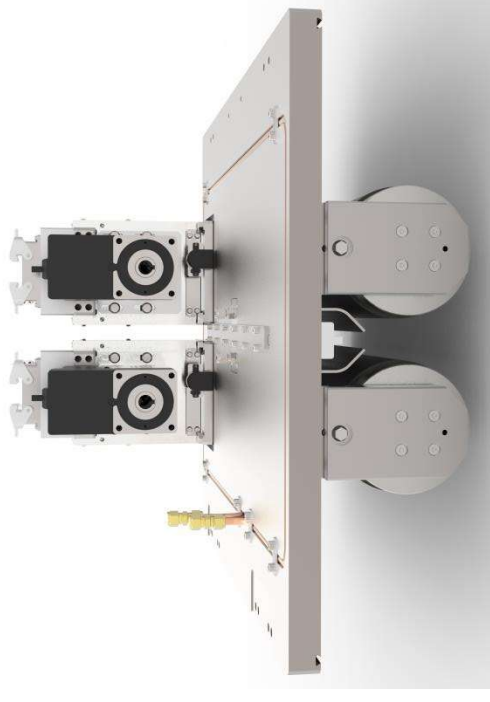

For DC and DC pulsed power the active anode is electrically floating an connected to the positive of the power supply. For AC type switching power the anode is at earth potential and can hence we a simpler construction.

Complete sub-assembly of triple GRS-C cathodes with 2 active anodes and gas bar

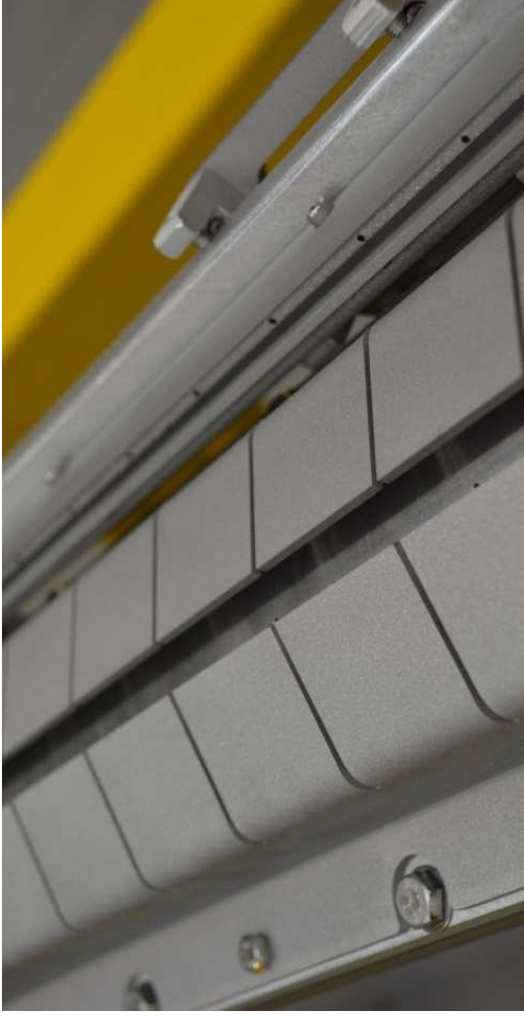



Gencoa Active Anodes reactive oxides with pulsed DC, a unique option compatible with AC and DC power modes

Gencoa's active anodes provides a long-term stable anode for rotatable magnetron operation which improves DC and pulsed DC processes from single or dual cathodes.



Highly insulating dielectric films can be deposited such as Al_2O_3 and SiO_2 with a single pulsed DC cathode and an active anode. This gives an alternative for dual cathodes with AC type power.

Active Anodes dramatically improves ITO layer properties from rotatable magnetrons, 2.3×10^{-4} resistivity at 120 C.



Al_2O_3 in metal mode



Al_2O_3 in transition mode



Al_2O_3 in full oxide mode

